

Micro Switch Catalogue

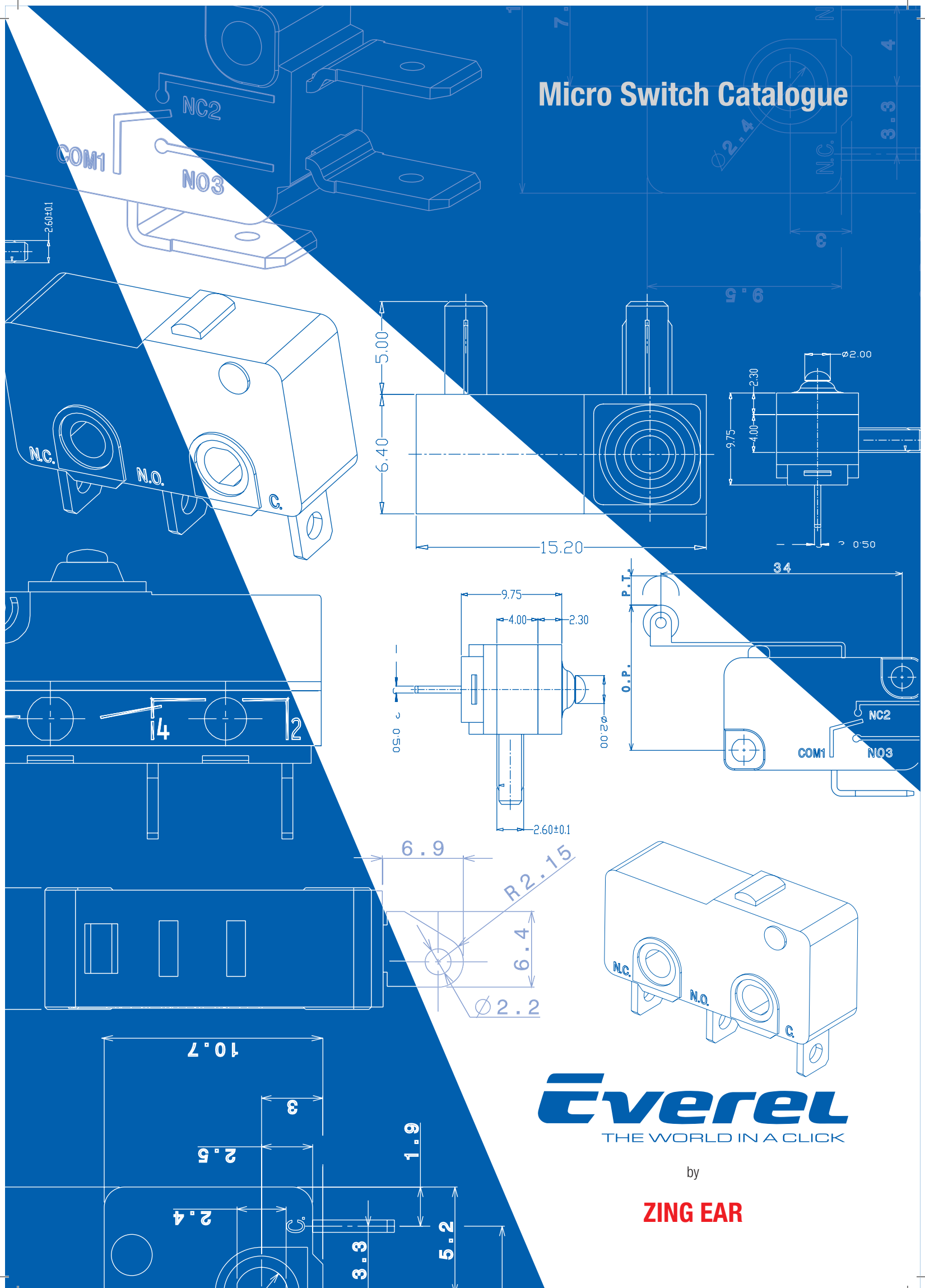

Everel
THE WORLD IN A CLICK

by

ZING EAR



Micro Switch Catalogue



by

ZING EAR

Glossary

Code	Name	Meanings
PT	Pre-travel	Distance or angle which actuator travels from Free Position to Operating Position.
OT	Over-travel	Distance or angle which actuator travels from Operating Position to Total Travel Position.
DT (or MD)	Movement-Differential	Distance or angle which actuator travels from Operating Position to Release Position.
RT	Release travel	The displacements of actuator from release position to free position.
OF	Operating force	Amount of force applied to switch actuator to cause snap action contact from Free Position Operating Position.
TF	Total travel force	Amount of force applied to actuator in order to move from Operating Position to Total Travel Position
RF	Release force	Amount of force applied to switch actuator in order to move from Total Travel Position to Release Position.
TTP	Total travel position	Position at where actuator reaches Over-Travel limit.
OP	Operating position	Position of actuator at where contacts snap from Free Position to Operating Position.
RP	Release position	Position of actuator at where contacts snap from Operating Position to Free Position.
FP	Free position	Position of actuator when no external force is applied.

Contents

	<p>G3 Subminiature sealed Micro Switch</p>	<p>04</p>
	<p>G303A/B Subminiature sealed Micro Switch</p>	<p>21</p>
	<p>G5 Basic Micro Switch</p>	<p>28</p>
	<p>G5W11 Water Proof Micro Switch</p>	<p>39</p>
	<p>G6 Miniature Micro Switch</p>	<p>43</p>
	<p>G9 Sealed Mini Micro Switch</p>	<p>48</p>
	<p>G91 Mini Micro Switch</p>	<p>56</p>
	<p>G9A/B 3.5 mm Travel Micro Switch</p>	<p>60</p>
	<p>G10 Series Subminiature Micro Switch</p>	<p>63</p>
	<p>G10A Series Subminiature Micro Switch</p>	<p>67</p>
	<p>G10B Series Subminiature Sealed Micro Switch</p>	<p>70</p>

G3 Series

Micro Switch Ordering Instruction

G3 series

G3	03	130	S		00	
Switch Type	Electrical Rating	Operating Force at pin Plunger Max	Terminal Style		Lever Type	
G3 Series Micro-Switch	03 ENEC 0.1 A 125/250VAC 48 VDC 3 A 12 VDC μ 1E5 UL 0.1 A 125/250VAC 48 VDC 3 A 12 VDC	130 130gf Max	E Molded lead wires downwards.	Q 2.5 x 7.5 mm type terminals	00 No lever Pin Plunger	23 23# lever (C1M3)
		...	G Molded lead wires on left side (plunger side)	Q1 2.5 x 6.7 mm type 1# terminals	01 Leaf lever (A, A1, M3)	25 25# lever (A, A1, M3)
			F Molded lead wires on right side (plunger side)	D 2.5 x 5.15 mm type 2# terminals	02 Straight Leaf lever (A, A1, M3)	28 28# lever (A, A1, M3)
			S Solder terminals	Q3 2.5 x 8.2 mm type 3# terminals	03 03# straight lever (Only for C type case)	31 Simulated Roller (A, A1, M3)
			M Short Solder terminals	A Left Side Fork type terminals	04 04# lever (A, A1, M3)	35 35# lever (A, A1, M3)
			K Long solder terminals	B Right Side Fork type terminals	05 Simulated Roller (A, A1, M3)	36 36# lever (A, A1, M3)
			N None-hole short Solder terminals	C Fork type terminals	08 Straight Leaf lever (A2)	37 37# lever (A, A1, PHA)
			P Straight PCB terminals (0.6 mm width) (0.6 mm, 3.5 mm)	W The B Solder terminals	09 Mini Simulated Roller lever (A, A1, M3)	38 38# lever (C1, C2)
			R Right side PCB terminals		10 10# lever (A, A1, PHA)	40 40# lever (C1, C2)
			L Left side PCB terminals		13 13# lever (Only for T type case)	41 41# lever (A, A1, M3)
			I Big Solder terminals (1.8 mm)		15 Upside down simulated roller lever (A, A1, M3)	45 45# lever (A, A1, M3)
			J Left Right straight PCB terminals		21 21# straight lever (Only for C type case)	52 52# lever (A, A1, M3)
					22 22# lever (A, A1, M3)	...

A	2		A	E	A	280
Circuit Code	Shape and Posts		Posts Dimension	AWG Type (for Wire type only)	AWG Number (for Wire type only)	Wires lenght
A SPDT	1 A type no post	17 D1 type left side posts	A ; A1; A2; B: 2.6 x 5.0 mm M3: 2.95 x 1.4 mm C1; C2; D1; D2: 2.95 x 1.5 mm C1M3: 3.00 x 1.5 mm	No molded lead wires	No molded lead wires	300 mm lenght standard lead wires
B SPST - NC	2 A type left side posts	18 D1 type right side posts	A ∅ 2.2 x 0.9 mm posts ∅ 2.2 x 0.9 mm (A A1)	M 18# Only applicable to bottom outlet switch	A UL1007	280 280 mm length
C SPST - NO	3 A type right side posts	19 D1 type two sides posts	B ∅ 2.5 x 1.5 mm posts ∅ 2.5 x 1.5 mm (A A1 B)	E 20# Only applicable to A type, A1 type, M3 type bottom outlet switch, C type out of the wo wire switch	C UL1430	... Other
	4 B type no post	28 A type no post	C ∅ 2.6 x 2.5 mm posts ∅ 2.6 x 2.5 mm (A A1)	F 22#	D UL1061	
	5 B type left side posts	29 A type left side posts	D Cross type ∅ 4.6 x 5.0 mm posts ∅ 4.6 x 5.0 mm	G 24#	E UL1330	
	6 B type right side posts	30 A type right side posts	E ∅ 2.95 x 0.75 mm posts	H 26#	F AVSS	
	7 M3 type posts	31 A type two sides posts	F ∅ 2.6 x 3.8 mm posts ∅ 2.6 x 3.8 mm (A A1)	I 28#	H UL1332	
	8 A type two sides posts	33 T type left side posts	H ∅ 2.6 x 2.0 mm posts ∅ 2.6 x 2.0 mm (A A1)	J 30#	L FLRY-A	
	9 B type two sides posts	34 T type right side posts	K ∅ 2.95 x 5.0 mm posts ∅ 2.95 x 5.0 mm (C C1)	K 32#	I UL3132	
	12 C1 type two sides posts	47 C1M3 type posts	J ∅ 2.6 x 1.4 mm posts ∅ 2.6 x 1.4 mm (A2)	L 34#	... Other	
	13 C1 type no post		L ∅ 2.6 x 1.4 mm posts ∅ 2.6 x 1.4 mm (A2)	... Other		
	14 C1 type left posts		... Other			
	15 C1 type right posts					
	16 D1 type no post					

G3	03	130	S	00	A	2	A	E	A	280
Switch Type	Electrical Rating	Operating Force at pin Plunger Max	Terminal Style	Lever Type	Circuit Code	Shape and Posts	Posts Dimension	AWG Type (for Wire type only)	AWG Number (for Wire type only)	Wires length

G3 series

Subminiature Sealed Micro Switch

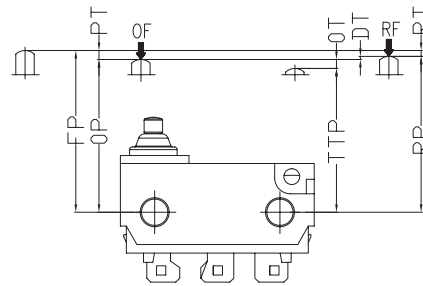
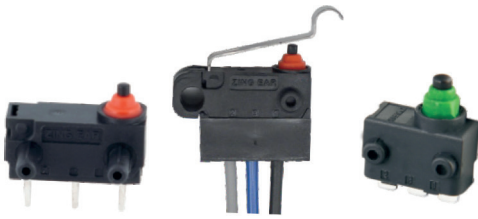

Features

- Designed for Water and Dust Tight (IP67)
- Small Compact Size
- Global Safety Approvals
- Long Life and High Reliability
- Variety of Levers
- Wide Range of Wiring Terminals
- Widely used in Automotive Electronics, Appliance and Industrial Control etc.
- Customized Designs

Applications

- Car
- Air Conditioner
- Communication
- Electric Tooth Brush
- Toys
- Home Appliances
- Motor Control

Parameters

Rating		0.1A, 125/250VAC; 3A/12VDC; 0.1A/48VDC; μ 1E5
Operating Frequency	Electrical	0.1A - 120; 3A - 10~30 cycles/minute
	Mechanical	120 cycles/minute
Contact Resistance (Initiative)		100m Ω Max (without wire type)
Insulation Resistance (at500VDC)		100m Ω Min
Vibration durability		10~55Hz, move0.75mm(p-p)
Dielectric Strenght		500VAC(50~60Hz)
Storage Temperature		-40°C ~ +85°C
Storage Humidity		85%RHMax
Service Life	Electrical	Min. 100,000 cycles (Depend on part No.)
	Mechanical	Min. 500,000 cycles

G3	03	130	S	00	A	2	A	E	A	280
Switch Type	Electrical Rating	Operating Force at pin Plunger Max	Terminal Style	Lever Type	Circuit Code	Shape and Posts	Posts Dimension	AWG Type (for Wire type only)	AWG Number (for Wire type only)	Wires length

Electrical Rating

03

ENEC:0.1A
125/250VAC
48VDC;3A 12VDC μ 1E5
UL: 0.1A 125/250VAC
48VDC;3A 12VDC

Operating Force at pin Plunger Max

130

130gf Max.

...

Other

Terminal Type

E Wires leads to bottom

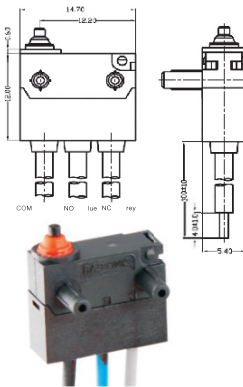

G Wires leads to left side (plunger side)

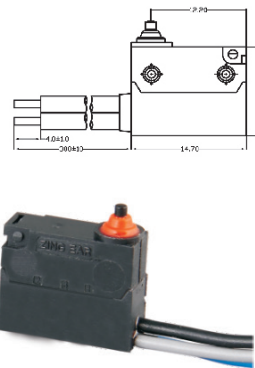

F Wires leads to right side (opposite to plunger side)

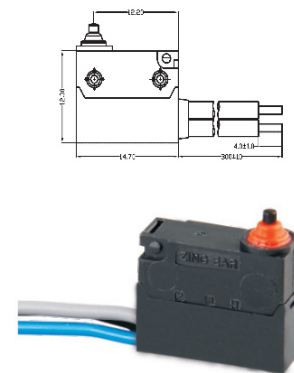

S Solder Terminals

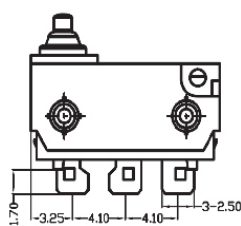

P Straight PCB Terminals

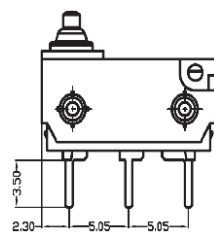

M Short Solder Terminals

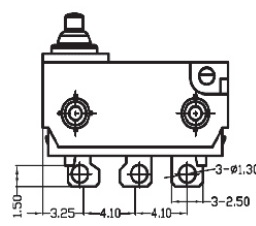

N No-hole Short Solder Terminals

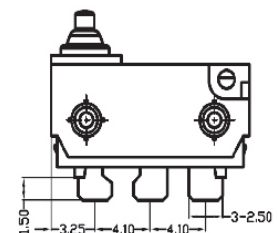

K Long Solder Terminals

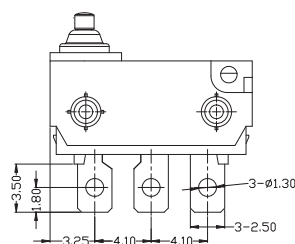

L Left Angled PCB Terminals

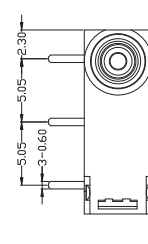

R Right Angled PCB Terminals

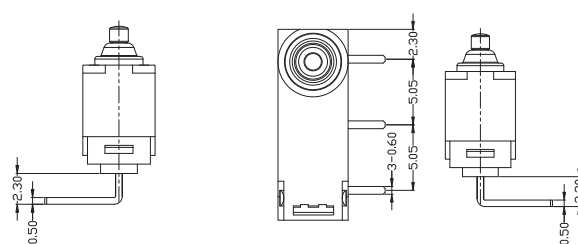

G3	03	130	S	00	A	2	A	E	A	280
Switch Type	Electrical Rating	Operating Force at pin Plunger Max	Terminal Style	Lever Type	Circuit Code	Shape and Posts	Posts Dimension	AWG Type (for Wire type only)	AWG Number (for Wire type only)	Wires length

I Big Solder Terminals	J Long Straight PCB Terminals	Q 2.5 Type Terminals
-------------------------------	--------------------------------------	-----------------------------

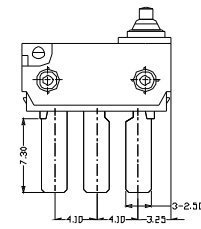
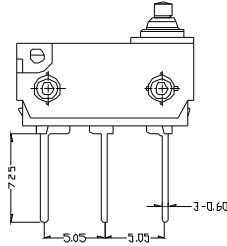
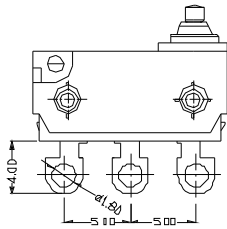

D 2.5 Type 2# Terminals	A Left Side Fork Type Terminals	B Right Side Fork Type Terminals
--------------------------------	----------------------------------------	-----------------------------------------

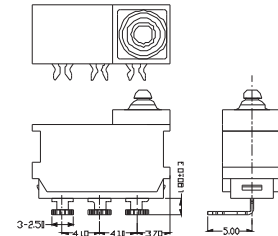
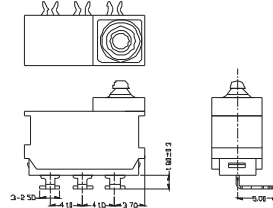
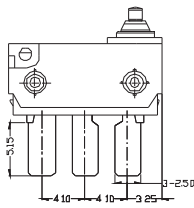

All terminals' thickness are 0.5 mm

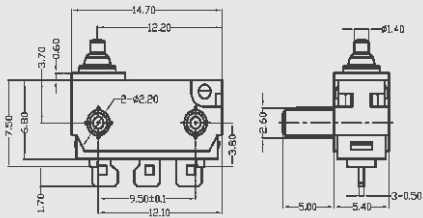

Lever Type

00 Pin Plunger	01 Leaf Lever	02 Straight Leaf Lever
-----------------------	----------------------	-------------------------------

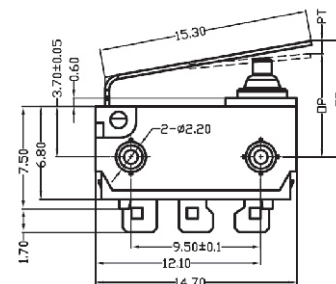
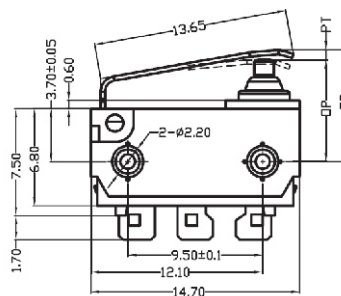
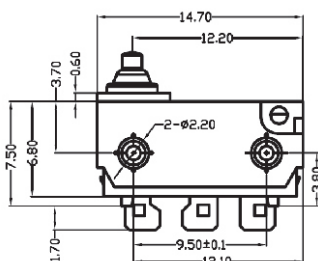

G3 Subminiature sealed Micro Switch

G3	03	130	S	00	A	2	A	E	A	280
Switch Type	Electrical Rating	Operating Force at pin Plunger Max	Terminal Style	Lever Type	Circuit Code	Shape and Posts	Posts Dimension	AWG Type (for Wire type only)	AWG Number (for Wire type only)	Wires length

03 Straight Leaf Lever

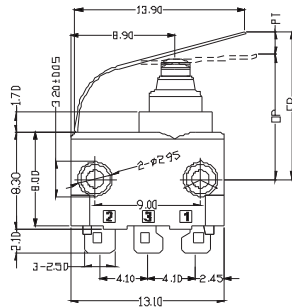

05 Simulated roller Leaf Lever

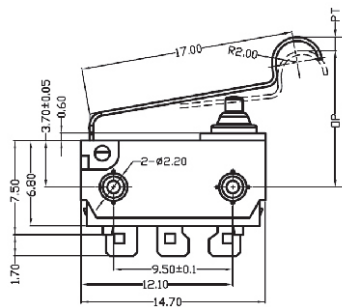

09 Mini Simulated roller Leaf Lever

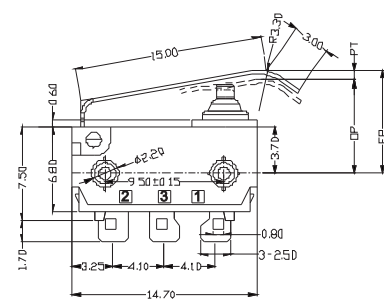

10# Lever

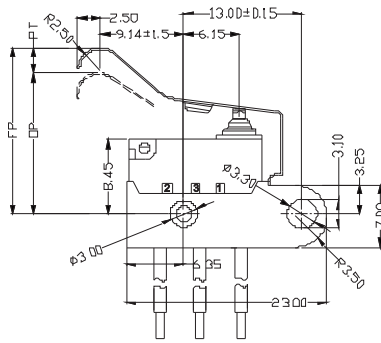

15 Upside Down Simulated Roller Lever

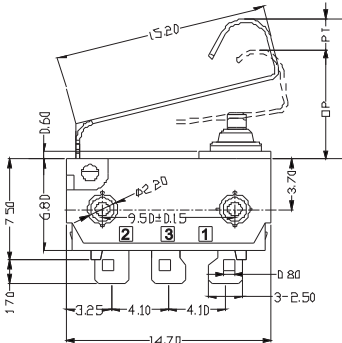

13# Lever

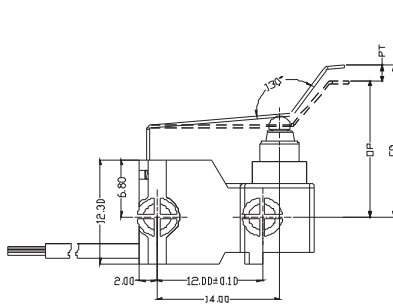

22# Lever

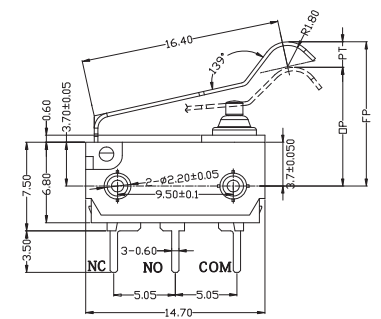

25# Lever

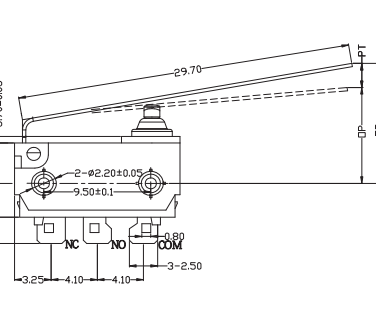

28# Lever

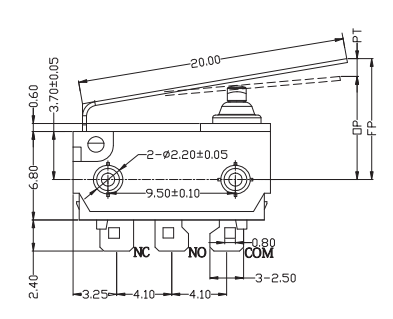

35# Lever

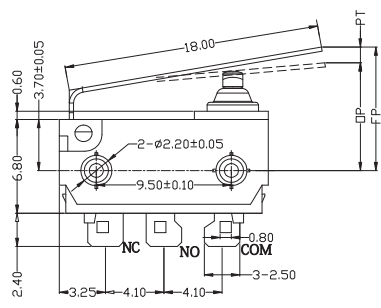

36# Lever

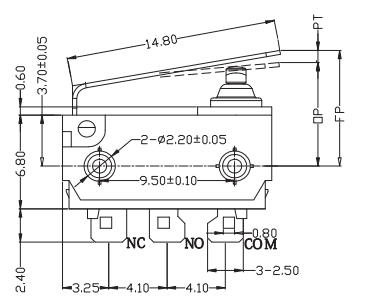

41# Lever

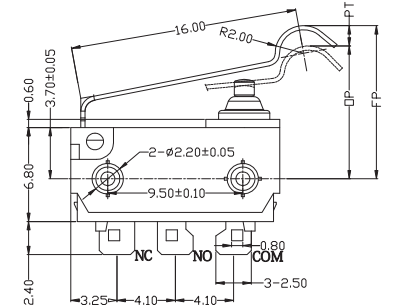

G3 series

G3	03	130	S	00	A	2	A	E	A	280
Switch Type	Electrical Rating	Operating Force at pin Plunger Max	Terminal Style	Lever Type	Circuit Code	Shape and Posts	Posts Dimension	AWG Type (for Wire type only)	AWG Number (for Wire type only)	Wires length

Circuit Configuration

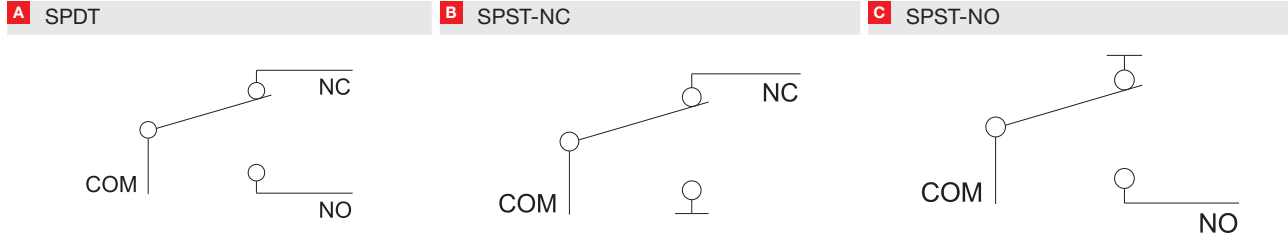

Mounting Hole Dimensions

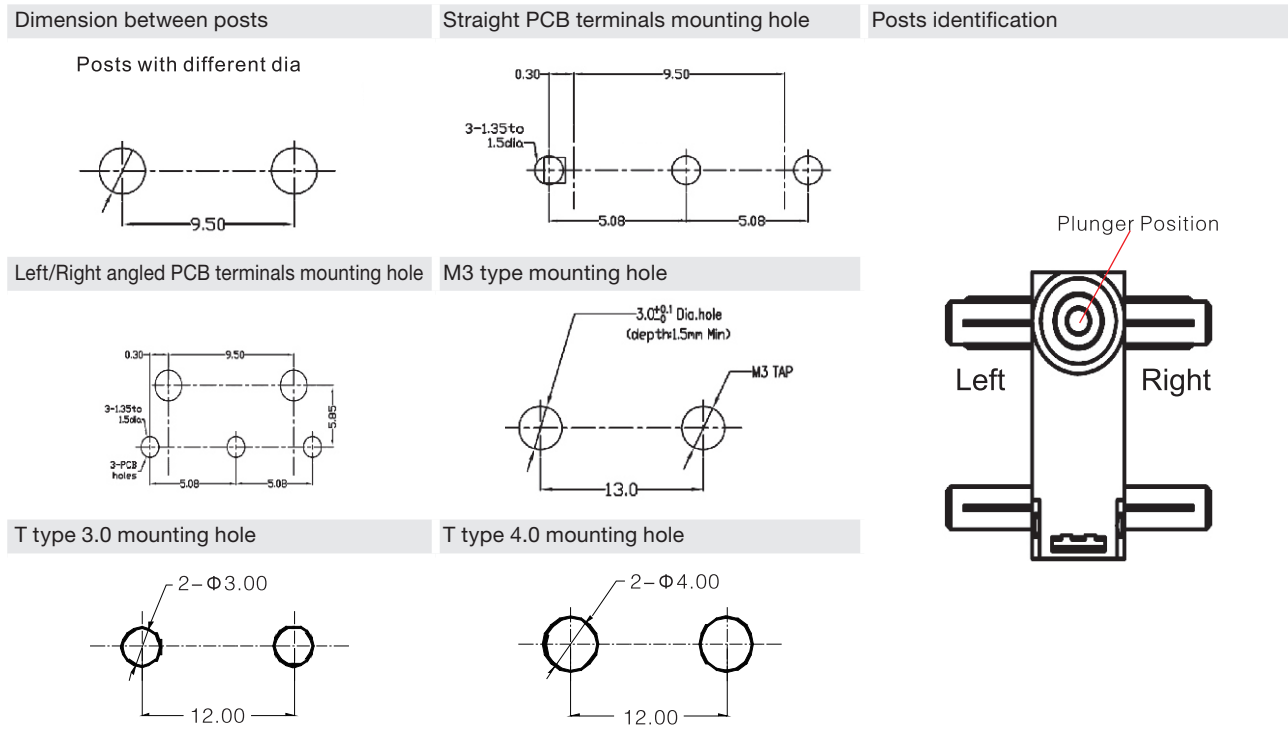

Shape

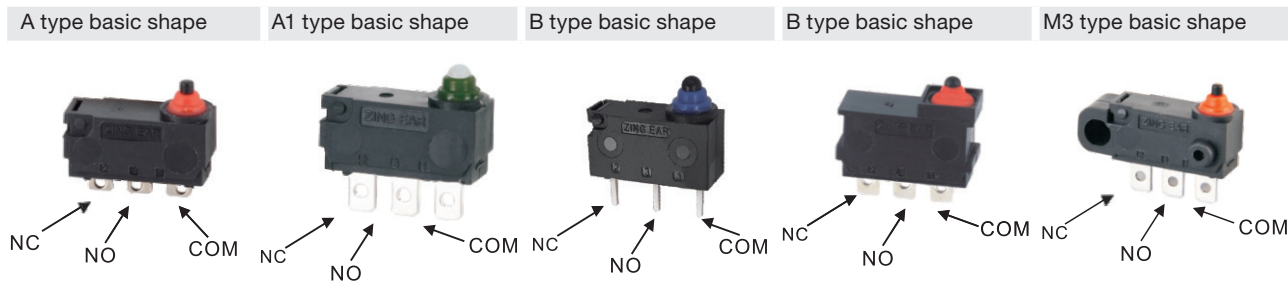

G3	03	130	S	00	A	2	A	E	A	280
Switch Type	Electrical Rating	Operating Force at pin Plunger Max	Terminal Style	Lever Type	Circuit Code	Shape and Posts	Posts Dimension	AWG Type (for Wire type only)	AWG Number (for Wire type only)	Wires length

C type basic shape

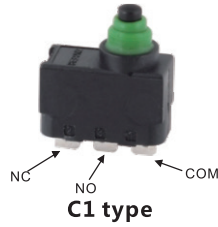

D type basic shape



C1M3 shape



T type basic shape

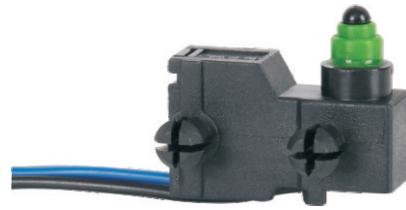

Posts

1 A type no post

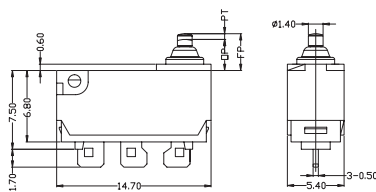

2 A type left side posts

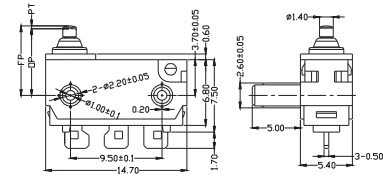

3 A type right side posts

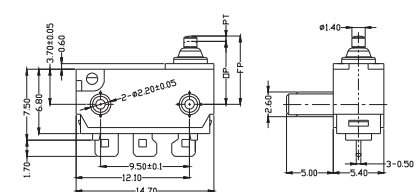

4 B type no post

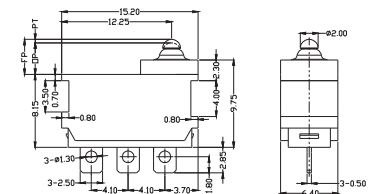

5 B type left side posts

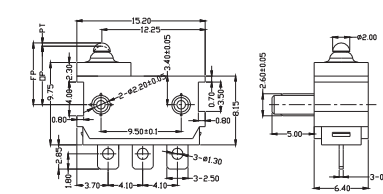

6 B type right side posts

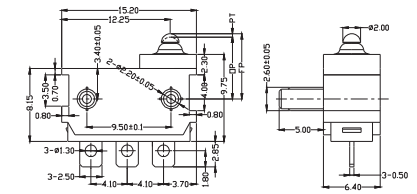

7 M3 type post

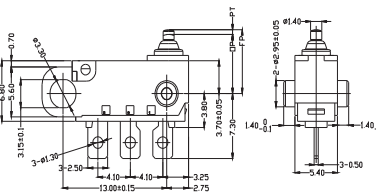

8 A type two side posts

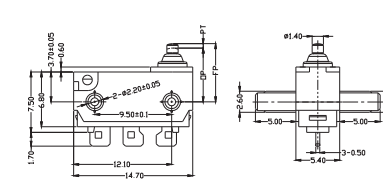

9 B type two side posts

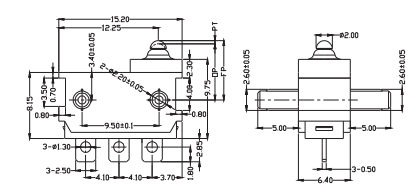

G3	03	130	S	00	A	2	A	E	A	280
Switch Type	Electrical Rating	Operating Force at pin Plunger Max	Terminal Style	Lever Type	Circuit Code	Shape and Posts	Posts Dimension	AWG Type (for Wire type only)	AWG Number (for Wire type only)	Wires length

12 20 C1/C2 type two side posts

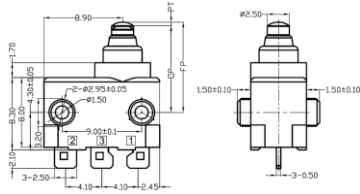

13 21 C1/C2 type no post

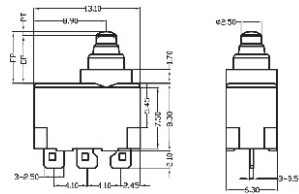

14 22 C1/C2 type left side posts

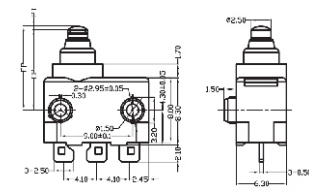

15 23 C1/C2 type right side posts

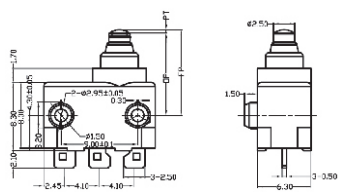

16 24 D1/D2 type no post

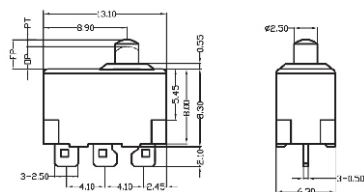

17 25 D1/D2 type left side posts

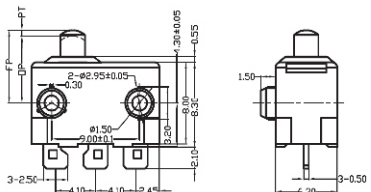

18 26 D1/D2 type right side posts

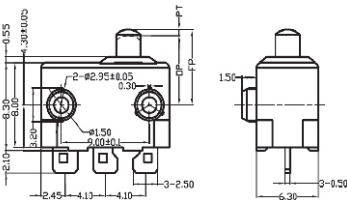

19 27 D1/D2 type two side posts

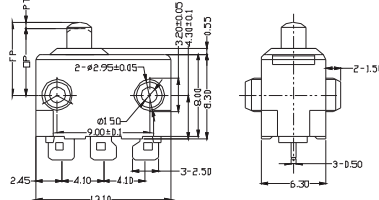

28 A1 type no post

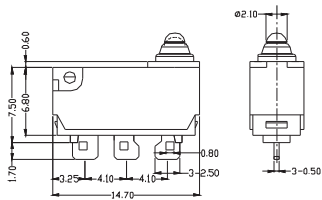

29 A1 type left side posts

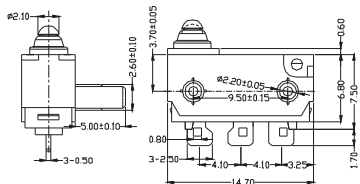

30 A1 type right side posts

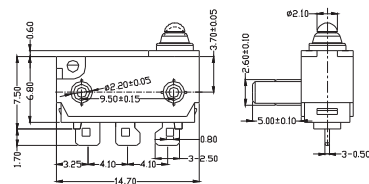

47 C1M3 type posts

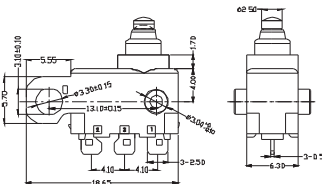

31 A1 type two side posts

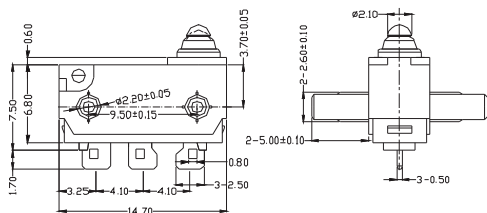

33 T type left side posts

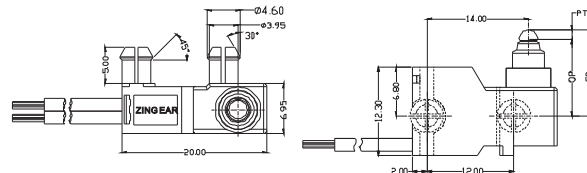

34 T type right side posts

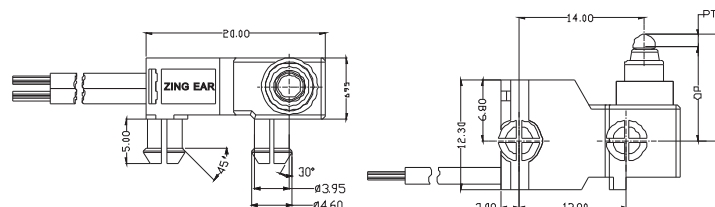

G3	03	130	S	00	A	2	A	E	A	280
Switch Type	Electrical Rating	Operating Force at pin Plunger Max	Terminal Style	Lever Type	Circuit Code	Shape and Posts	Posts Dimension	AWG Type (for Wire type only)	AWG Number (for Wire type only)	Wires length

Post Dimension

Standard posts: ϕ 2.6 x 5.0 mm

A ϕ 2.2 x 0.9 mm posts

B ϕ 2.5 x 1.5 mm posts

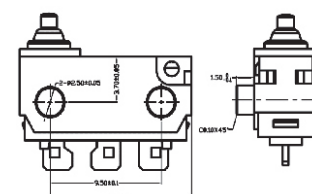
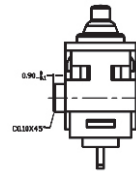
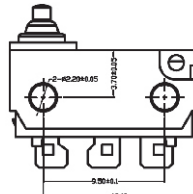
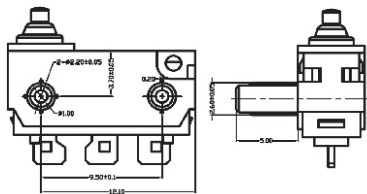

C ϕ 2.6 x 2.5 mm posts

F ϕ 2.6 x 3.8 mm posts

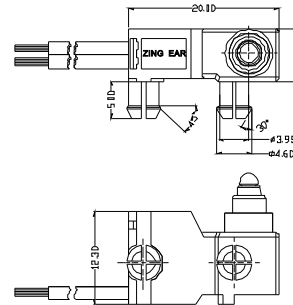
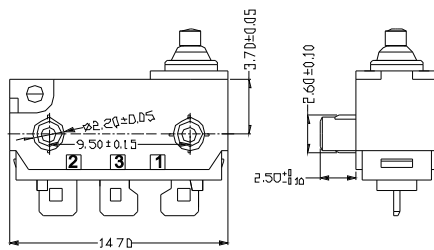

D ϕ 4.6 x 5.0 mm posts

E ϕ 2.95 x 0.75 mm posts

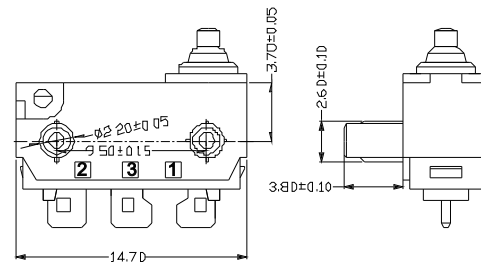
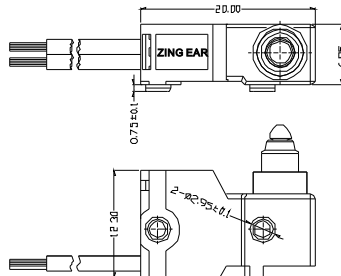

AWG Type (for Wire type only)

No molded lead wires

- M** 18# (Only applicable to bottom outlet switch)
- E** 20# (Only applicable to A type, A1 type, M3 type bottom outlet switch, C type out of the wo wire switch)
- F** 22#
- G** 24#
- H** 26#
- I** 28#
- J** 30#
- K** 32#
- L** 34#
- ...** Other

AWG Number (for Wire type only)

No molded lead wires

- A** UL1007
- C** UL1430
- D** UL1061
- E** UL1330
- F** AVSS
- H** UL1332
- L** FLRY-A
- I** UL3132
- ...** Other

Wires length

300 mm length standard lead wires

- 280** 280 mm length
- ...** Other

G3	03	130	S	00	A	2	A	E	A	280
Switch Type	Electrical Rating	Operating Force at pin Plunger Max	Terminal Style	Lever Type	Circuit Code	Shape and Posts	Posts Dimension	AWG Type (for Wire type only)	AWG Number (for Wire type only)	Wires length

Dimensions and Operating Characteristics

G3 □□-□□□ S00A1

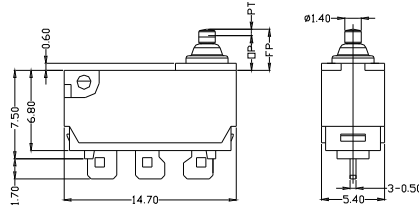

OF Max (gf)	RF Min (gf)	PT Max (mm)	OT Min (mm)	DT Max (mm)	FP Max (mm)	OP (mm)	
-130	130	13	0.8	0.8	0.2	3.65	3.05±0.2

G3 □□-□□□ S01A1

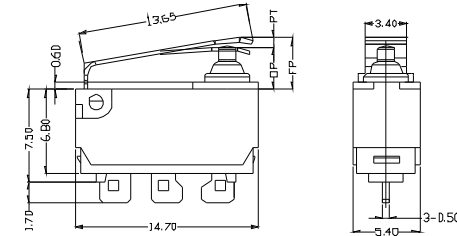

OF Max (gf)	RF Min (gf)	PT Max (mm)	OT Min (mm)	DT Max (mm)	FP Max (mm)	OP (mm)	
-130	220	30	3	0.8	0.5	5.7	3.4±0.5

G3 □□-□□□ S02A1

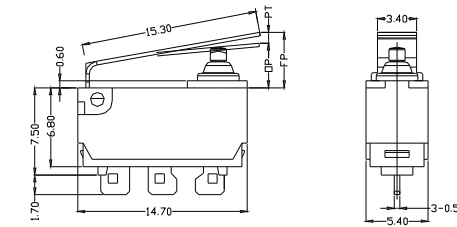

OF Max (gf)	RF Min (gf)	PT Max (mm)	OT Min (mm)	DT Max (mm)	FP Max (mm)	OP (mm)	
-130	195	25	3.5	1.35	0.6	6.8	3.7±0.6

G3 □□-□□□ S05A1

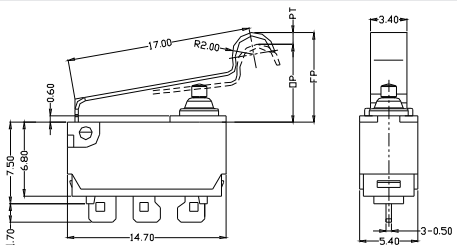

OF Max (gf)	RF Min (gf)	PT Max (mm)	OT Min (mm)	DT Max (mm)	FP Max (mm)	OP (mm)	
-130	180	20	3.8	1.5	0.7	9.8	7.0±0.7

G3 □□-□□□ S00A3

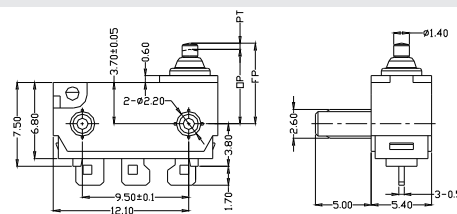

OF Max (gf)	RF Min (gf)	PT Max (mm)	OT Min (mm)	DT Max (mm)	FP Max (mm)	OP (mm)	
-130	130	13	0.8	0.8	0.2	7.35	6.75±0.2

G3 □□-□□□ S01A3

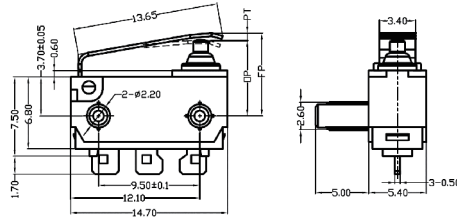

OF Max (gf)	RF Min (gf)	PT Max (mm)	OT Min (mm)	DT Max (mm)	FP Max (mm)	OP (mm)
-130	220	30	3	0.8	0.5	9.4
						7.1±0.5

G3 □□-□□□ S02A3

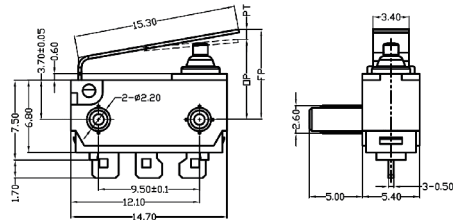

OF Max (gf)	RF Min (gf)	PT Max (mm)	OT Min (mm)	DT Max (mm)	FP Max (mm)	OP (mm)
-130	195	25	3.5	1.35	0.6	10.5
						7.4±0.6

G3 □□-□□□ S05A3

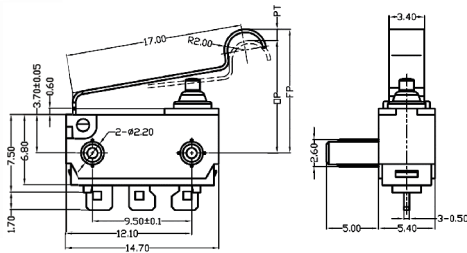

OF Max (gf)	RF Min (gf)	PT Max (mm)	OT Min (mm)	DT Max (mm)	FP Max (mm)	OP (mm)
-130	180	20	3.8	1.5	0.7	13.5
						10.7±0.7

G3 □□-□□□ S09A3

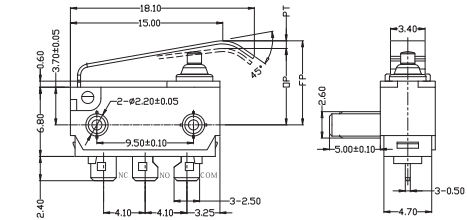

OF Max (gf)	RF Min (gf)	PT Max (mm)	OT Min (mm)	DT Max (mm)	FP Max (mm)	OP (mm)
-130	195	30	3.5	1.3	0.6	10.8
						7.3±0.6

G3 □□-□□□ P15A3

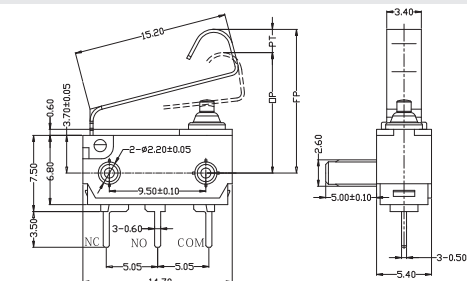

OF Max (gf)	RF Min (gf)	PT Max (mm)	OT Min (mm)	DT Max (mm)	FP Max (mm)	OP (mm)
-130	280	30	4	1.5	0.7	15.9
						11.9±0.7

G3 □□-□□□ P22A3

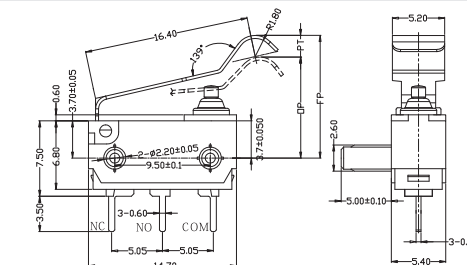

OF Max (gf)	RF Min (gf)	PT Max (mm)	OT Min (mm)	DT Max (mm)	FP Max (mm)	OP (mm)
-130	200	20	3.8	1.5	0.7	13.8
						10.0±0.7

G3 □□-□□□ S25A3

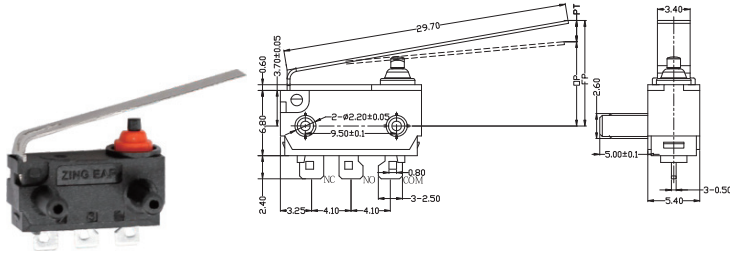

OF Max (gf)	RF Min (gf)	PT Max (mm)	OT Min (mm)	DT Max (mm)	FP Max (mm)	OP (mm)
-130	150	25	5.5	1.35	1.5	7.50±1.2

G3 □□-□□□ S28A3

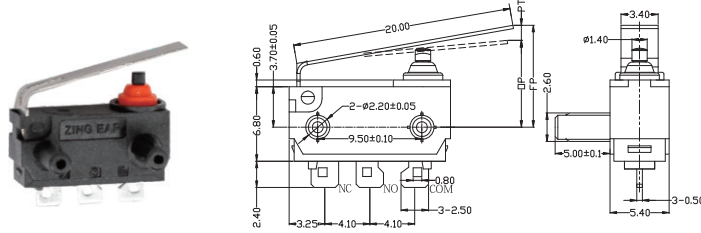

OF Max (gf)	RF Min (gf)	PT Max (mm)	OT Min (mm)	DT Max (mm)	FP Max (mm)	OP (mm)
-130	200	25	4.5	1.5	1	7.15±1.0

G3 □□-□□□ S35A3

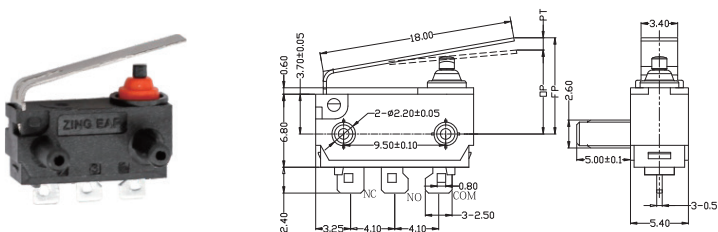

OF Max (gf)	RF Min (gf)	PT Max (mm)	OT Min (mm)	DT Max (mm)	FP Max (mm)	OP (mm)
-130	200	25	4.4	1.5	1	7.05±1.0

G3 □□-□□□ S36A3

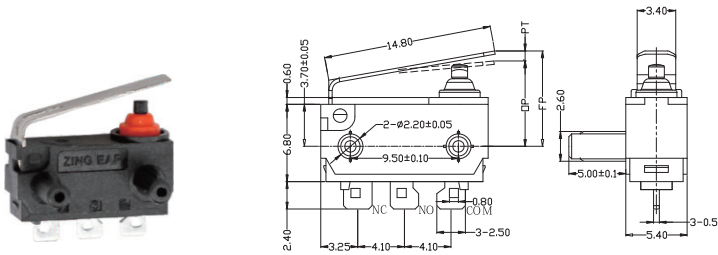

OF Max (gf)	RF Min (gf)	PT Max (mm)	OT Min (mm)	DT Max (mm)	FP Max (mm)	OP (mm)
-130	200	25	3.4	1.3	0.6	7.2±0.6

G3 □□-□□□ P41A3

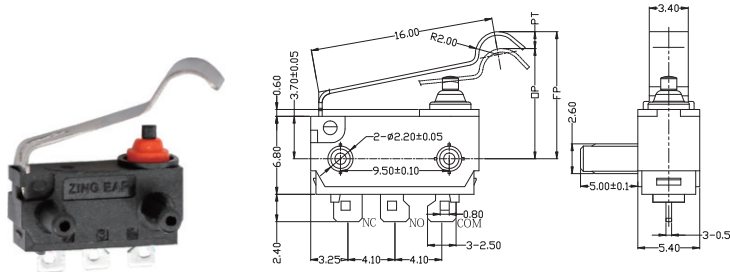

OF Max (gf)	RF Min (gf)	PT Max (mm)	OT Min (mm)	DT Max (mm)	FP Max (mm)	OP (mm)
-130	200	50	3.5	1.2	0.6	9.5±0.7

G3 □□-□□□ G00A3

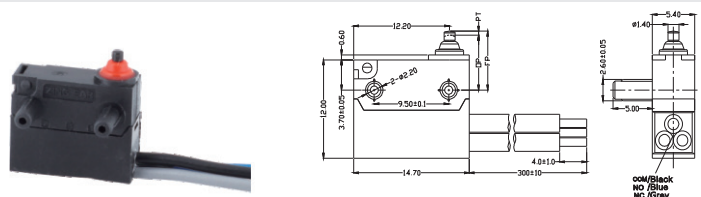

OF Max (gf)	RF Min (gf)	PT Max (mm)	OT Min (mm)	DT Max (mm)	FP Max (mm)	OP (mm)
-130	130	13	0.8	0.8	0.2	6.75±0.2

G3 □□-□□□ S00A13

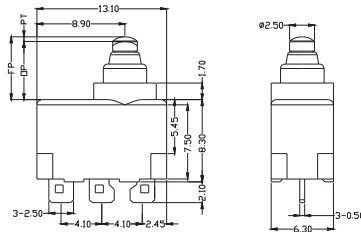

OF Max (gf)	RF Min (gf)	PT Max (mm)	OT Min (mm)	DT Max (mm)	FP Max (mm)	OP (mm)
-130	180	20	1.5	0.5	0.25	6.35

G3 □□-□□□ S00A15

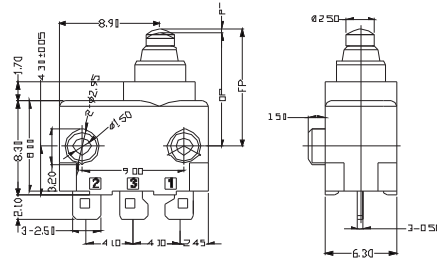

OF Max (gf)	RF Min (gf)	PT Max (mm)	OT Min (mm)	DT Max (mm)	FP Max (mm)	OP (mm)
-130	180	20	1.5	0.5	0.25	10.35

G3 □□-□□□ S03A12

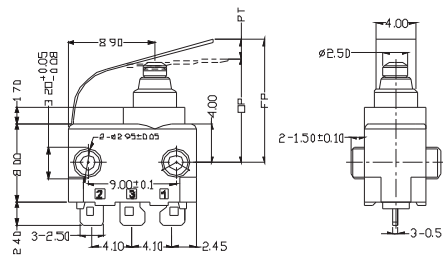

OF Max (gf)	RF Min (gf)	PT Max (mm)	OT Min (mm)	DT Max (mm)	FP Max (mm)	OP (mm)
-130	250	50	5.5	0.5	1.1	15

G3 □□-□□□ S00A16

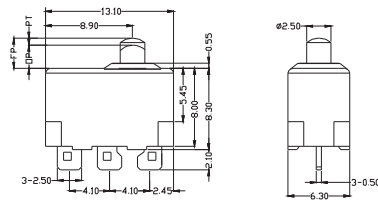

OF Max (gf)	RF Min (gf)	PT Max (mm)	OT Min (mm)	DT Max (mm)	FP Max (mm)	OP (mm)
-130	130	8	1.5	0.5	0.25	3.3

G3 □□-□□□ S00A18

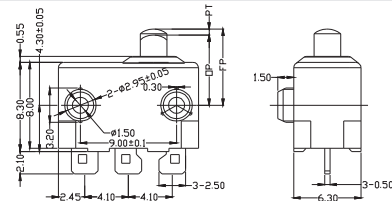

OF Max (gf)	RF Min (gf)	PT Max (mm)	OT Min (mm)	DT Max (mm)	FP Max (mm)	OP (mm)
-130	130	8	1.5	0.5	0.25	7.3

G3 □□-□□□ E00A47 - □□

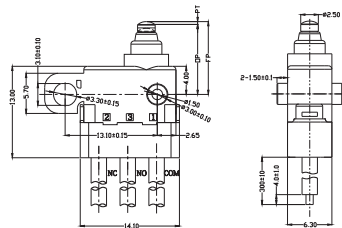

OF Max (gf)	RF Min (gf)	PT Max (mm)	OT Min (mm)	DT Max (mm)	FP Max (mm)	OP (mm)	TTP
-130	200	20	15	0.5	0.25	10.45	9.4±0.3

G3 □□-□□□ E23A47 - □□

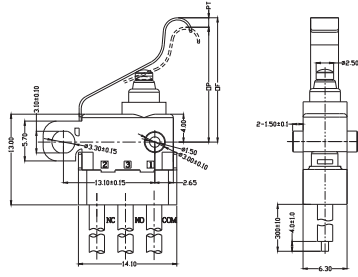

OF Max (gf)	RF Min (gf)	PT Max (mm)	OT Min (mm)	DT Max (mm)	FP Max (mm)	OP (mm)	TTP	
-130	300	50	3.5	0.5	1.1	18.50	16.45±1.5	14.9

G3 □□-□□□ K00A4

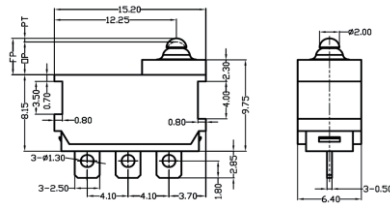

OF Max (gf)	RF Min (gf)	PT Max (mm)	OT Min (mm)	DT Max (mm)	FP Max (mm)	OP (mm)	
-130	130	13	0.8	0.8	0.2	4.1	3.45±0.2

G3 □□-□□□ K00A6

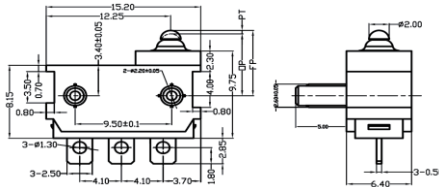

OF Max (gf)	RF Min (gf)	PT Max (mm)	OT Min (mm)	DT Max (mm)	FP Max (mm)	OP (mm)	
-130	130	13	0.8	0.8	0.2	7.5	6.85±0.2

G3 □□-□□□ K00A7

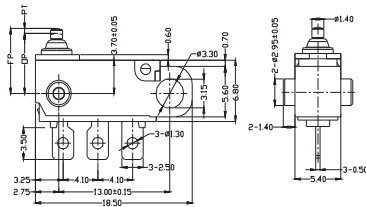

OF Max (gf)	RF Min (gf)	PT Max (mm)	OT Min (mm)	DT Max (mm)	FP Max (mm)	OP (mm)	
-130	130	13	0.8	0.8	0.2	7.35	6.75±0.2

G3 □□-□□□ K05A7

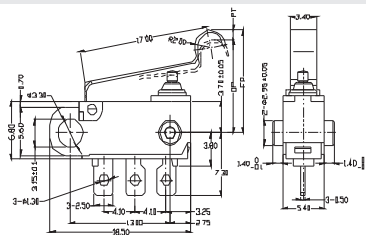

OF Max (gf)	RF Min (gf)	PT Max (mm)	OT Min (mm)	DT Max (mm)	FP Max (mm)	OP (mm)	
-130	180	20	3.8	1.5	0.7	13.5	10.7±0.7

G3 □□-□□□ K01A2

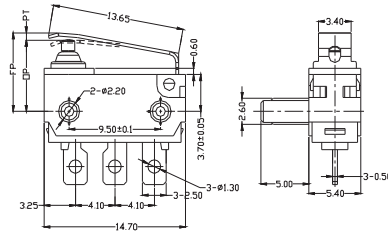

OF Max (gf)	RF Min (gf)	PT Max (mm)	OT Min (mm)	DT Max (mm)	FP Max (mm)	OP (mm)	
-130	220	30	2	0.8	0.5	9.4	
							7.1±0.5

G3 □□-□□□ P00A3

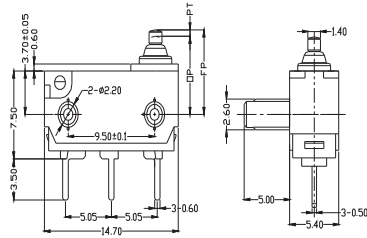

OF Max (gf)	RF Min (gf)	PT Max (mm)	OT Min (mm)	DT Max (mm)	FP Max (mm)	OP (mm)	
-130	130	13	0.8	0.8	0.2	7.35	
							6.75±0.2

G3 □□-□□□ E00A3 - □□

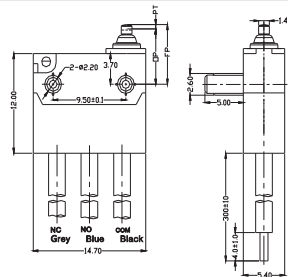

OF Max (gf)	RF Min (gf)	PT Max (mm)	OT Min (mm)	DT Max (mm)	FP Max (mm)	OP (mm)	
-130	130	13	0.8	0.8	0.2	7.35	
							6.75±0.2

G3 □□-□□□ E37C1

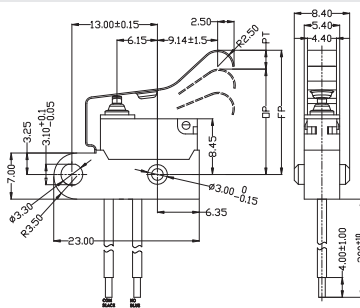

OF Max (gf)	RF Min (gf)	PT Max (mm)	OT Min (mm)	DT Max (mm)	FP Max (mm)	OP (mm)	
-130	100	25	6	1.5	2	21	
							15±2.0

G3 □□-□□□ E00A7 - □□

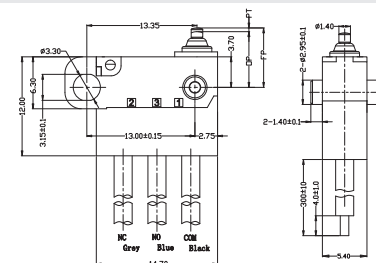

OF Max (gf)	RF Min (gf)	PT Max (mm)	OT Min (mm)	DT Max (mm)	FP Max (mm)	OP (mm)	
-130	130	13	0.8	0.8	0.2	7.35	
							6.75±0.2

G3 □□-□□□ E05A7 - □□

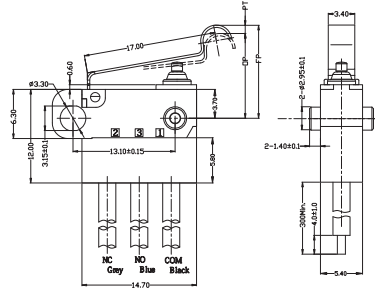

OF Max (gf)	RF Min (gf)	PT Max (mm)	OT Min (mm)	DT Max (mm)	FP Max (mm)	OP (mm)
-130	180	20	3.8	1.5	0.7	13.5

G3 □□-□□□ P00A52

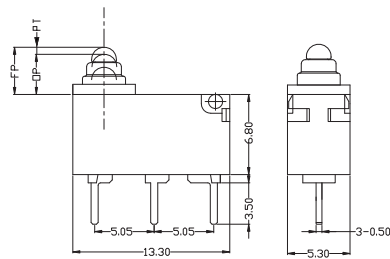

OF Max (gf)	RF Min (gf)	PT Max (mm)	OT Min (mm)	DT Max (mm)	FP Max (mm)	OP (mm)	TTP	
-130	130	30	1.3	0.6	0.25	4.2	3.4±0.3	2.3

G3 □□-□□□ P00A53

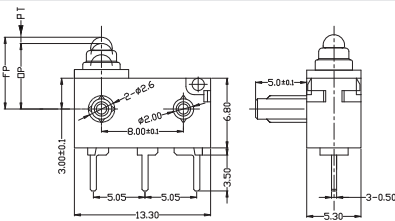

OF Max (gf)	RF Min (gf)	PT Max (mm)	OT Min (mm)	DT Max (mm)	FP Max (mm)	OP (mm)	TTP	
-130	130	30	1.3	0.6	0.25	7.2	6.4±0.3	5.3

G3 □□-□□□ E00A48 - □□

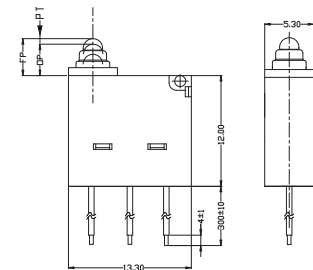

OF Max (gf)	RF Min (gf)	PT Max (mm)	OT Min (mm)	DT Max (mm)	FP Max (mm)	OP (mm)	TTP	
-130	130	30	1.3	0.6	0.25	4.2	3.4±0.3	2.3

G3 □□-□□□ E00A49 - □□

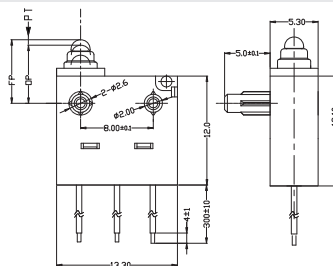

OF Max (gf)	RF Min (gf)	PT Max (mm)	OT Min (mm)	DT Max (mm)	FP Max (mm)	OP (mm)	TTP	
-130	130	30	1.3	0.6	0.25	7.2	6.4±0.3	5.3

G3	03	A	180	K	00	A	20	A	E	A	280
Switch Type	Electrical Rating	Sub family	Operating Force at pin Plunger Max	Terminal Style	Lever Type	Circuit Code	Shape and Posts	Posts Dimension	AWG Type (for Wire type only)	AWG Number (for Wire type only)	Wires length

G303A/B series

Subminiature Sealed Micro Switch

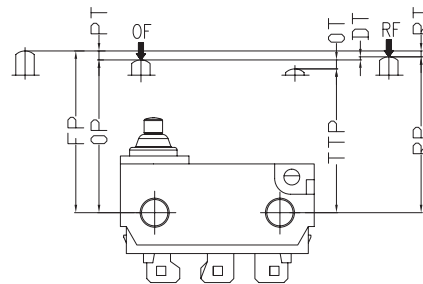
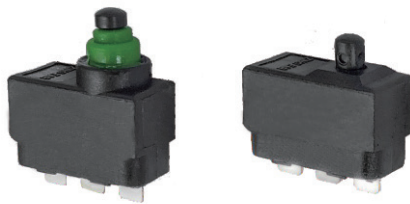

Features

- Designed for Water and Dust Tight (IP67)
- Small Compact Size
- Global Safety Approvals, Customer Designs
- Long range and High Reliability
- Wide Range of Wiring Terminals
- Variety of Levers
- Widely used in Automotive Electronics, Appliance and Industrial Control
- Variety of shapes

Applications

- Car
- Air Conditioner
- Communication
- Electric Tool Brush
- Toys
- Bicycle

Parameters

Rating		0.1A / 125VAC; 3A/12VDC; 0.1A/250VAC; 0.1A/48VDC μ 1E5
Operating Frequency	Electrical	0.1A - 120; 3A - 10~30 cycles/minute
	Mechanical	120 cycles/minute
Contact Resistance (Initiative)		100m Ω Max
Insulation Resistance (at500VDC)		100m Ω Min
Vibration durability		10~55Hz, move 0.75mm(p-p)
Dielectric Strenght		500VAC(50~60Hz)
Storage Temperature		-40°C ~ +85°C
Storage Humidity		85%RHMax
Service Life	Electrical	100,000 cycles
	Mechanical	Min. 500,000 cycles

G303A/B Series

Micro Switch Ordering Instruction

G303A/B series

G3	03	A	180	K	00
Switch Type	Electrical Rating	Sub family	Operating Force at pin Plunger Max	Terminal Style	Lever Type
G3 Series Micro-Switch	03 ENEC 0.1 A 125/250VAC 48 VDC 3 A 12 VDC μ 1E5 UL 0.1 A 125/250VAC 48 VDC 3 A 12 VDC	A IP67	180 180gf Max	E Molded lead wires downwards.	00 No lever Pin Plunger
		B IP40	130 130gf Max	G Molded lead wires on left side (plunger side)	03 03# straight lever (Only for C type case)
				F Molded lead wires on right side (plunger side)	38 38# lever (C1, C2)
				K Long solder terminals	... Other
				I Big Solder terminals (1.8 mm)	
				P Straight PCB terminals (0.6 mm width) (0.6 mm, 3.5 mm)	
				R Right side PCB terminals	
				L Left side PCB terminals	
				J Left Right straight PCB terminals	
				S Solder terminals	
				... Other	

A	20	A	E	A	280
Circuit Code	Shape and Posts	Posts Dimension	AWG Type (for Wire type only)	AWG Number (for Wire type only)	Wires lenght
A SPDT	20 C2 type two sides posts	A	No molded lead wires	No molded lead wires	300 mm lenght standard lead wires
B SPST - NC	21 C2 type no post	B ø 2.95 x 5.0 mm posts	E 20#	A UL1007	280 280 mm length
C SPST - NO	22 C2 type left posts	C ø 2.95 x 1.5 mm posts	F 22#	F AVSS	... Other
	23 C2 type right posts	... Other	G 24#	L FLRY-A	
	24 D2 type no post		... Other	... Other	
	25 D2 type left side posts				
	26 D2 type right side posts				
	27 D2 type two sides posts				
	... Other				

G3	03	A	180	K	00	A	20	A	E	A	280
Switch Type	Electrical Rating	Sub family	Operating Force at pin Plunger Max	Terminal Style	Lever Type	Circuit Code	Shape and Posts	Posts Dimension	AWG Type (for Wire type only)	AWG Number (for Wire type only)	Wires length

Electrical Rating

03
ENEC
 0.1 A 125/250VAC 48 VDC
 3 A 12 VDC μ 1E5
UL
 0.1 A 125/250VAC 48 VDC
 3 A 12 VDC

Sub family

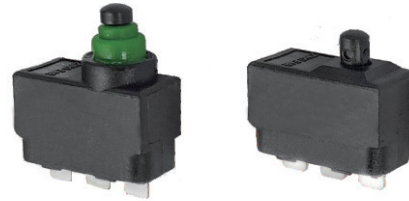

A
IP67

B
IP40

Operating Force at pin Plunger Max

180
180gf Max.

130
130gf Max.

Terminal Type

E Wires leads to bottom

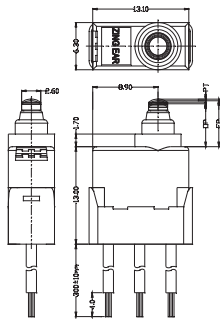

G Wires leads to left side (plunger side)

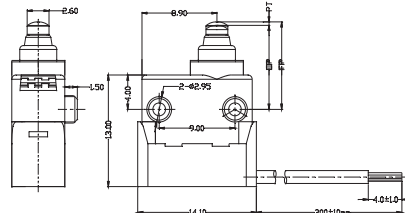

F Wires leads to right side (opposite to plunger side)

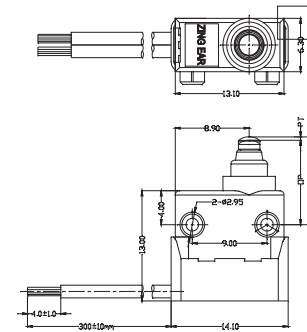

P Straight PCB Terminals

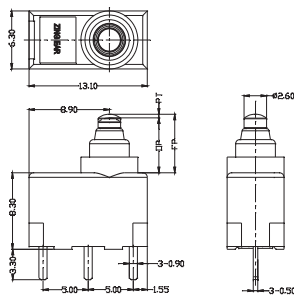

I Big Solder Terminals

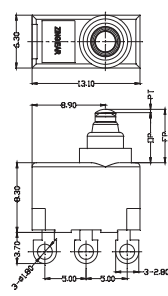

K Long Solder Terminals

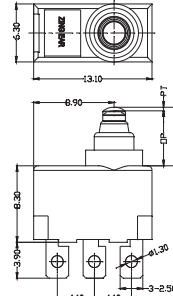

J Long Straight PCB Terminals

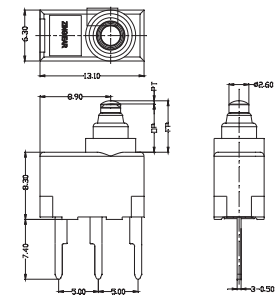

G3	03	A	180	K	00	A	20	A	E	A	280
Switch Type	Electrical Rating	Sub family	Operating Force at pin Plunger Max	Terminal Style	Lever Type	Circuit Code	Shape and Posts	Posts Dimension	AWG Type (for Wire type only)	AWG Number (for Wire type only)	Wires length

Lever Type

03 Straight leaf lever

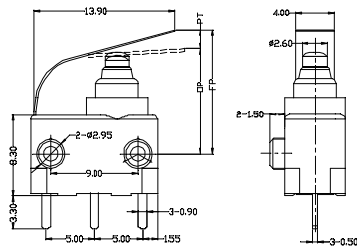

38 Leaf Lever

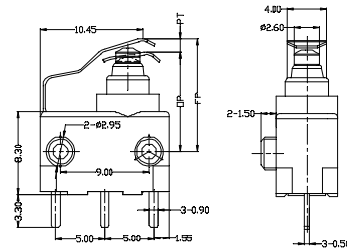

Contact Configuration

A SPDT

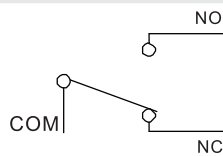

B SPST-NC

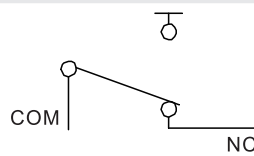

C SPST-NO

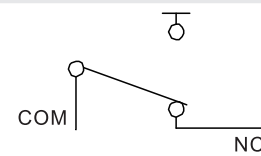

Mounting Hole Dimensions

Dimension between posts

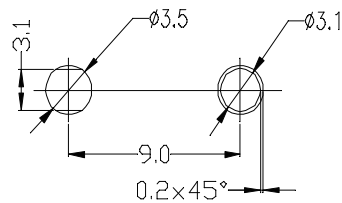

Posts direction define

Dimension between posts

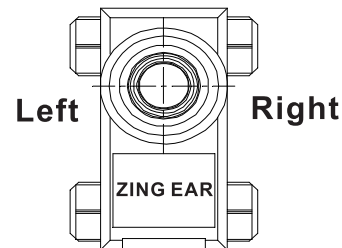

Shape and Posts

20 C2 type two sides posts

21 C2 type no post

22 C2 type left posts

23 C2 type right posts

24 D2 type no post

25 D2 type left side posts

26 D2 type right side posts

27 D2 type two sides posts

... Other

G3	03	A	180	K	00	A	20	A	E	A	280
Switch Type	Electrical Rating	Sub family	Operating Force at pin Plunger Max	Terminal Style	Lever Type	Circuit Code	Shape and Posts	Posts Dimension	AWG Type (for Wire type only)	AWG Number (for Wire type only)	Wires length

Posts Dimension

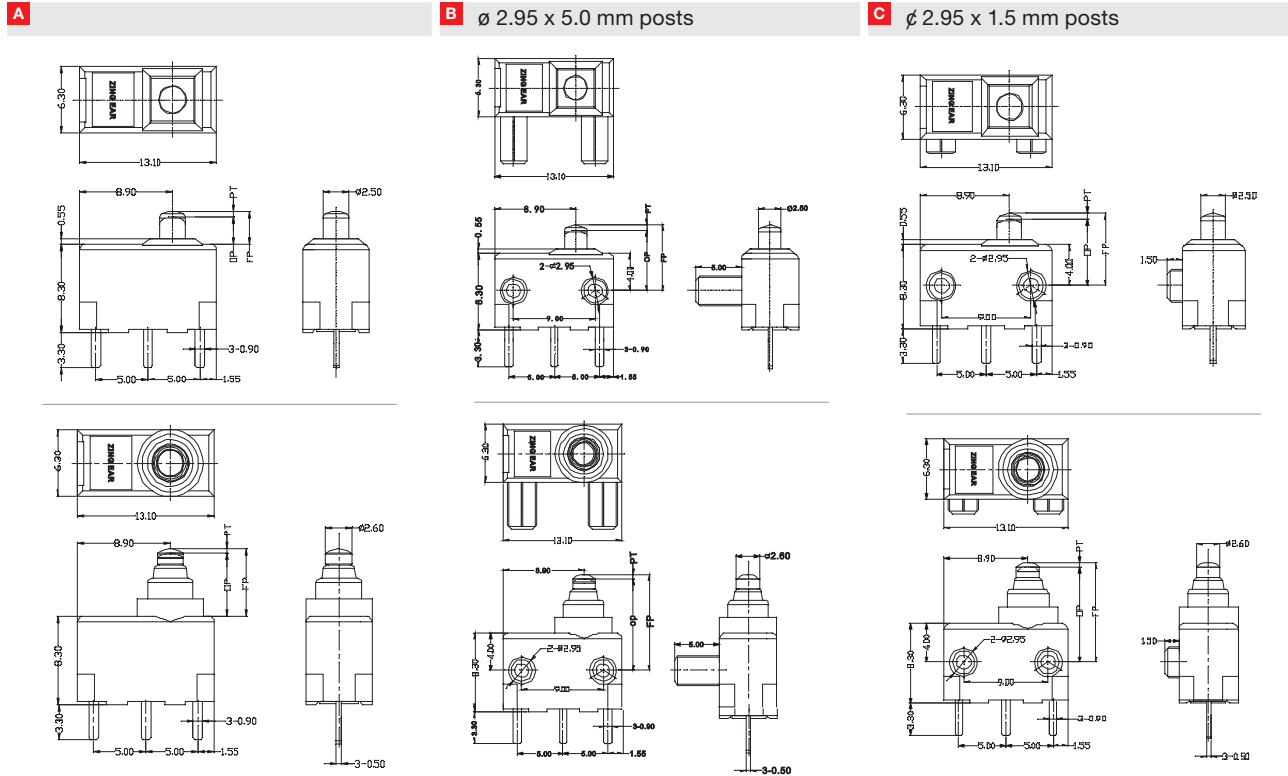

AWG Type (for Wire type only)

No molded lead wires

- E** 20#
- F** 22#
- G** 24#
- ...** Other

AWG Number (for Wire type only)

No molded lead wires

- A** UL1007
- F** AVSS
- L** FLRY-A
- ...** Other

Wires length

300 mm length standard lead wires

- 280** 280 mm length
- ...** Other

Dimensions and Operating Characteristics

G303A-18P00A21A

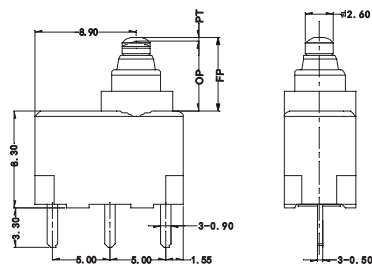

G303A/B Subminiature sealed Micro Switch

G3	03	A	180	K	00	A	20	A	E	A	280
Switch Type	Electrical Rating	Sub family	Operating Force at pin Plunger Max	Terminal Style	Lever Type	Circuit Code	Shape and Posts	Posts Dimension	AWG Type (for Wire type only)	AWG Number (for Wire type only)	Wires length

G303A-18P00423C

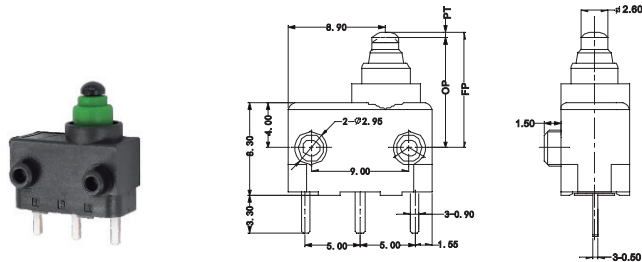

OF	RF	PT	OT	DT	FP	OP
-180	180	20	1.5	0.7	0.4	10.35

G303B-130P00A24A

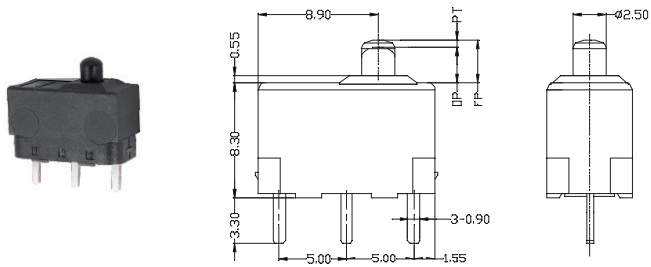

OF	RF	PT	OT	DT	FP	OP
-130	130	8	1.5	0.7	0.4	3.3

G303B-130P00A26C

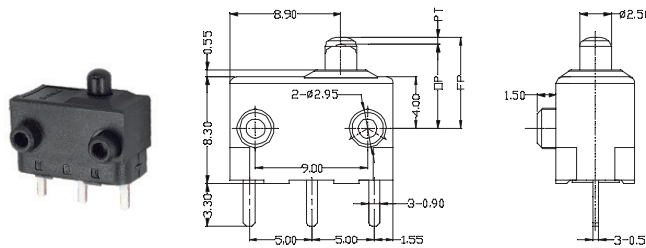

OF	RF	PT	OT	DT	FP	OP
-130	130	8	1.5	0.7	0.4	7.3

G303A-180P03A23C

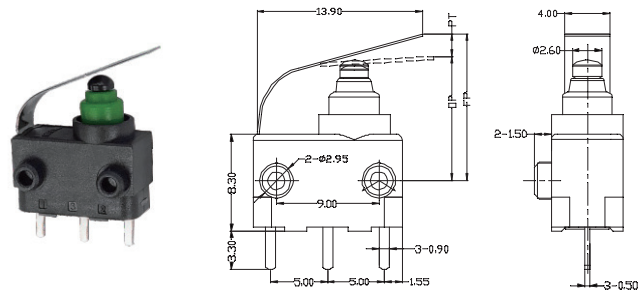

OF	RF	PT	OT	DT	FP	OP
-180	250	50	5.5	0.7	1.1	14

G303A-180P38A23C

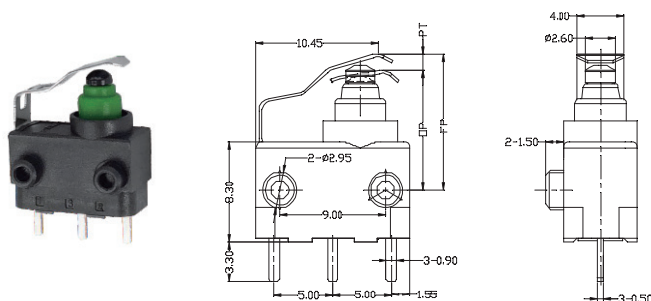

OF	RF	PT	OT	DT	FP	OP
-180	250	50	2	0.7	1.1	12

G5 Series

Basic Micro Switch

G5 series

G5	T	16	C	Z
Switch Type	Temperature grade	Electrical Rating	Terminal Type	Circuit Code
G5 Series Micro-Switch	S 25T85 (for "05" rating only)	05 ENEC/CQC: 0.1A48VDC 0.1A 125/250VAC 5(2.S)A 125/250VAC,5E4,u UL/CUL: 0.1A48VDC 0.1A 125/250VAC 5A 1/10HP 125/250VAC "S" Temperature grade only. Only apply to C, C1, C2, H, E1, E2, D, D1, D2, S, S1, S2, F, F1)	C C1 C2 6.30x0.8mm 0.250"x0.032" Quick Connect Terminal	Z SPDT
	T 25T125	08 ENEC/CQC 8(10)A 250VAC,5E4,25T125 UL/CUL 10.1A1/2HP 250VAC Above only for"B" temperature grade and switch of contact gap>3mm) and only with C2 and D2 terminals; "300"-~"500" OF only	D D1 D2 4.80x0.8mm 0.187"x0.032" Quick Connect Terminal	P SPST - NO
	H 25T150	10 UL/CUL: 1A 30VDC 10A 1/2HP 125/250VAC (Above only for"H" temperature grade)	E E1 E2 4.70x0.5mm 0.187"x0.020" Quick Connect Terminal	R R1 R2 Right Angled PCB Terminals
	B 25T125 Only for "08" rating and contact gap>3mm	UL/CUL: 11A 1/3HP 125/250VAC 0.5A 125VDC 0.25A 250VDC 4A 125VAC L ENEC/CQC 10(3)A 125/250VAC,0.5A 125VDC 0.25A 250VDC 25T125 μ 5E4 (Above only for "T" temperature grade) C1, C2, E, E1, E2, D, D1, D2, F, F1 Terminal only.	L L1 L2 Left Angled PCB Terminals	S S1 S2 Solder Terminals
	F 25T85 IEC IP64 Only for rating "10"	----- 10(4)A 250V AC 25T85 μ 5E4 IP64 Only for G5F "IP64" waterproof grade	T T1 T2 ScrewTerminals	X X1 X2 Special Connect
		16 ENEC/CQC: 16(4)A 250VAC μ 5E4 UL/CUL: 16A 1/2HP 125/250VAC	H H1 H2 Rast - 5	S S1 S2 Solder Terminals
	22 ENEC 16(13)A 250VAC μ 5E4 22(8)A 250VAC μ 1E4 CQC 22(8)A 250VAC μ 1E4 UL/CUL 22A HP 125/250VAC	N N1 N2 Rast - 7	T T1 T2 ScrewTerminals	
	26 ENEC/CQC: 26(10)A 250VAC, 0.02A 250VAC, 25E3 μ	P P1 P2 PCB	X X1 X2 Special Connect	
		J 6.30x0.80mm 0.250"x0.032" Quick connect	H H1 H2 Rast - 5	
			N N1 N2 Rast - 7	
			P P1 P2 PCB	
			J 6.30x0.80mm 0.250"x0.032" Quick connect	

Note:
Other available lever include:
08#, 09#, 23#, 24#, 32#, 45#,
46#...

Note: Letters for Basic Case/ Cover only type

200	A	01	B	K	280
Max Operating Force at Pin Plunger	Lever Position	Lever Type	Housing Color	Mounting Holes	Special Designator
015 15gf Note: Only apply to G5S05, G5W11 (Rating1) series.	No lever Pin Plunger	No lever Pin Plunger	Grey	Metric ø 3.1 mm	Here means a special designator letter. Refer to products specification for detailed differences.
025 25gf Note: Only apply to G5S05, G5W11 (Rating1) series.	A Far From Pin Plunger	01 Short Straight Lever	B Black	K ø 2.9 mm	H Rast-5 250# terminal
050 50gf 0.49N Note: Only apply to G5S05, G5W11 (Rating1 & Rating 2) series.	B Close to Pin Plunger	02 Std. Straight Lever	M 750 °C Glow Wire 750 °C	U Alloy base with inner mounting hole Only for G5D Door Switch	N Rast-7 250# terminal
100 100gf 0.98N Note: 16A and 22A Minimum OFI s 100gf.	F Push Rod G5D Door switch only	03 Long Straight Lever		V Alloy base with outer mounting hole Only for G5D Door Switch	P Straight PCB Terminal
200 200gf 1.96N Note: G5S05, G5T10, G5W11 Series 200gf/with maximum OF is 200gf	J Screw Push Rod G5D Door switch only	04 Simulated Roller Lever		W Alloy base with two switches Only for G5D Door Switch	A Contact gold plated
300 300gf 2.94N Note: Not apply to G5S05, G5T10, G5W11 Series.		05 Roller Lever			
400 400gf 3.92N Note: Not apply to G5S05, G5T10, G5W11 Series.		06 Long Roller Lever			
500 500gf 4.90N "B" Temperature grade only		...			
1800 1800gf 17.64N "G5D Door switch" only		99 Special Lever			

G5	T	16	C	Z	200	A	01	B	K	280
Switch Type	Temperature Grade	Electrical Rating	Terminal Type	Circuit Code	Max Operating Force at Pin Plunger	Lever Position	Lever Type	Housing Color	Mounting Holes	Special Designator

G5 Series

Basic Micro Switch

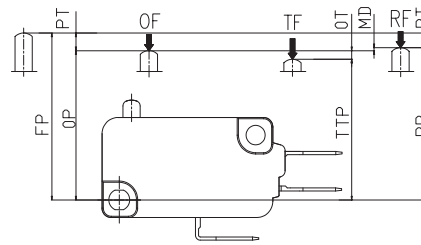
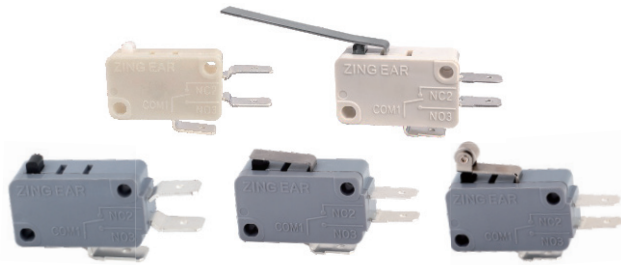

Features

- Tight Configuration, Small Contact Gap, Snap Action, High Sensitivity and Small Operating Travel
- Long Life, High Reliability
- Global Safety Approvals
- Variety of Terminals
- Wide Range Operating Force (7gf~600gf)
- Wide Range Temperature Grade (-40°C~+ 150°C), 200°C Optional
- With Optional PTI Grade (175v, 250v, 600v)
- Variety of Levers
- Widely Used in Home Appliances, Electronic Equipments, Automatic Machines, Communication Equipments, Auto Electronics, Apparatus and Instrument, Power Tool etc

Applications

- Home Appliances
- Electronic Equipments
- Automatic Equipments
- Communication Equipments
- Auto Electronics
- Apparatus and Instruments
- Power Tools

Parameters

Operating Speed	0.1 mm-1 m/s (Related with actuator forms)	
Operating Frequency	Mechanical 60 cycles/min; Electrical 15 cycles/min.	
Insulation Resistance	≥ 1 00M Q (500VDC)	
Contact Resistance	≤ 100m Q (Initial value)	
Voltage Resistance	Between each terminals of the same polarity	AC1 000V, 50/60HZ, 1 min.
	Between current carrying metal part and ground and between each terminal and non-current carrying metal parts	AC1500V, 50/60HZ, 1 min.
Vibration Resistance	10-55HZ, 1.5mm Double amplitude	
Shock Resistance	Destruction: OF > 1.0N: 1 000m/s ² (approx. 100G) max.	
	Destruction: OF ≤ 1.0N: 400m/s ² (approx. 40G) max.	
Service Life	Mechanical ≥ 10,000,000 cycles or 1,000,000 cycles or 50,000 cycles	
	Electrical ≥ 50,000 cycles or 100,000 cycles Depends on Part No.	
Unit Net Weight	6.2g Approx. 6.2g (No lever)	

G5	T	16	C	Z	200	A	01	B	K	280
Switch Type	Temperature Grade	Electrical Rating	Terminal Type	Circuit Code	Max Operating Force at Pin Plunger	Lever Position	Lever Type	Housing Color	Mounting Holes	Special Designator

Temperature grade

S 25T85 (for "05" rating only)

T 25T125

H 25T150

B 25T125 Only for "08" rating and contact gap>3mm

F 25T85, IEC IP64 Only for rating "10"

10

UL/CUL:
1A 30VDC
10A 1/2HP 125/250VAC
 (Above only for "H" temperature grade)

UL/CUL:
11A 1/3HP 125/250VAC
0.5A 125VDC 0.25A 250VDC
4A 125VAC L
ENEC/CQC
10(3)A 125/250VAC,0.5A 125VDC 0.25A 250VDC
25T125 μ 5E4
 (Above only for "T" temperature grade) C1, C2, E, E1, E2, D, D1, D2, F, F1 Terminal only.

Electrical Rating

05

ENEC/CQC:
0.1A48VDC
0.1A 125/250VAC
5(2.S)A 125/250VAC,5E4,u

UL/CUL:
0.1A48VDC
0.1A 125/250VAC
5A 1/10HP 125/250VAC

"S" Temperature grade only. Only apply to C, C1, C2, H, E1, E2, D, D1, D2, S, S1, S2, F, F1)

08

ENEC/CQC
8(10)A 250VAC,5E4,25T125
UL/CUL
10.1A1/2HP 250VAC

Above only for "B" temperature grade and switch of contact gap>3mm) and only with C2 and D2 terminals; "300"~"500" OF only

10(4)A 250V AC
25T85 μ 5E4
IP64
 Only for G5F "IP64" waterproof grade

16

ENEC/CQC:
16(4)A 250VAC μ 5E4
UL/CUL:
16A 1/2HP
125/250VAC

22

ENEC
16(13)A 250VAC μ 5E4
22(8)A 250VAC μ 1E4
CQC
22(8)A 250VAC μ 1 E4
UL/CUL
22A HP
125/250VAC

26

ENEC/CQC:
26(10)A 250VAC, 0.02A 250VAC, 25E3 μ

Inner Construction

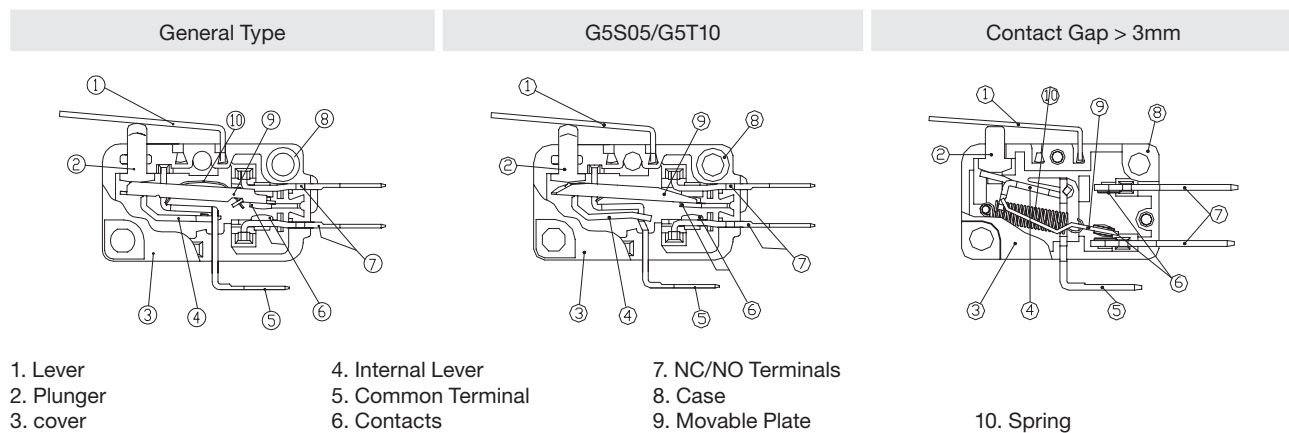

G5	T	16	C	Z	200	A	01	B	K	280
Switch Type	Temperature Grade	Electrical Rating	Terminal Type	Circuit Code	Max Operating Force at Pin Plunger	Lever Position	Lever Type	Housing Color	Mounting Holes	Special Designator

Mounting Hole Dimensions

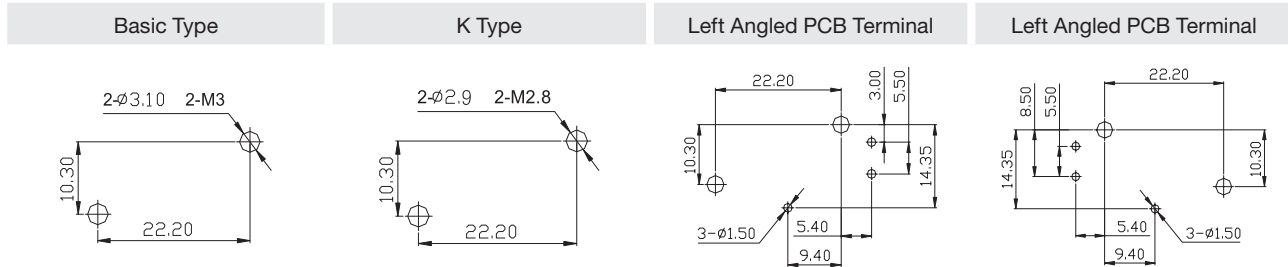

Housing Outline Characteristics

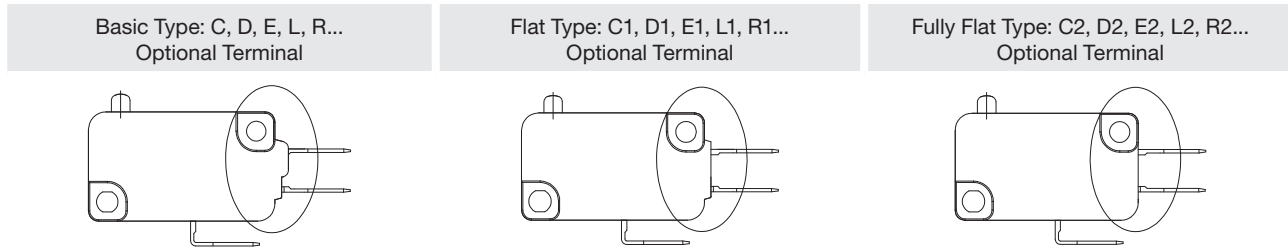

Terminal for Basic Type Housing

- C** Basic Type Housing with 250# Quick Connect Terminals, T=0.8(C)
- D** Basic Type Housing with 187# Quick Connect Terminals, T=0.8(D)
- E** Basic Type Housing with 187# Quick Connect Terminals, T=0.5(E)

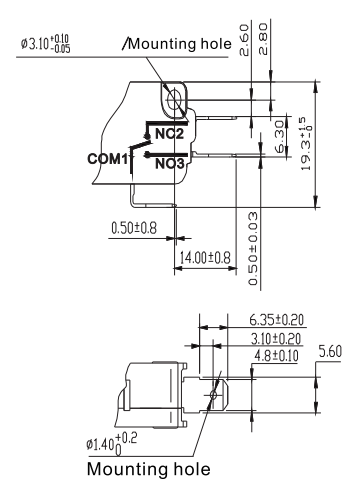
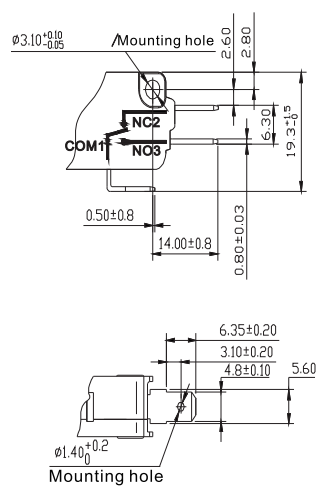
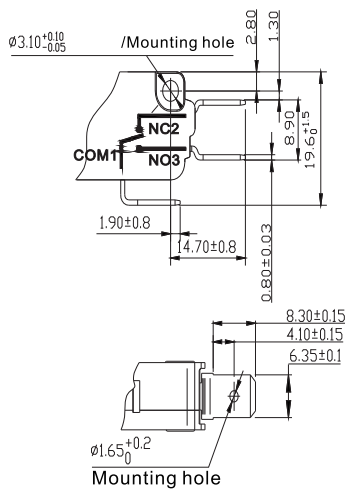

G5	T	16	C	Z	200	A	01	B	K	280
Switch Type	Temperature Grade	Electrical Rating	Terminal Type	Circuit Code	Max Operating Force at Pin Plunger	Lever Position	Lever Type	Housing Color	Mounting Holes	Special Designator

Terminal for Flat Type Housing

C1 Flat Type Housing with 250# Quick Connect Terminals, T=0.8(C1)

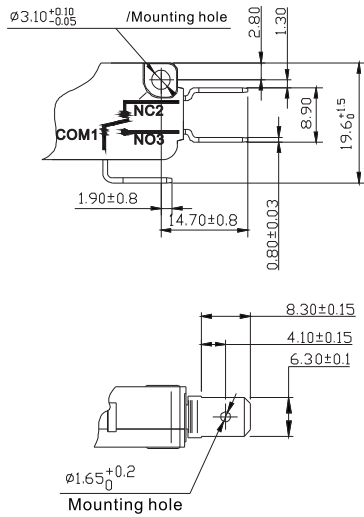

D1 Flat Type Housing with 187# Quick Connect Terminals, T=0.8(D1)

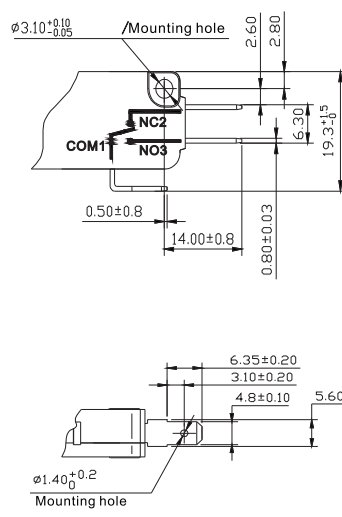

E1 Flat Type Housing with 187# Quick Connect Terminals, T=0.5(E1)

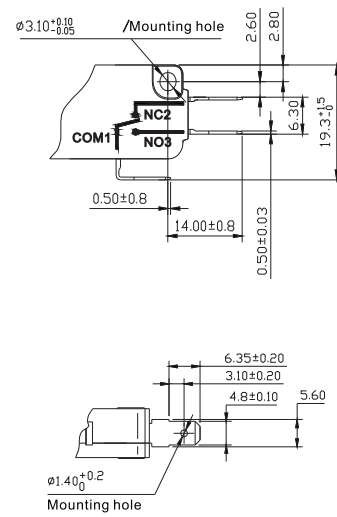

Terminal for Flat Type Housing

B2 Fully Flat Type 250# Quick Connect Terminals, T=0.8

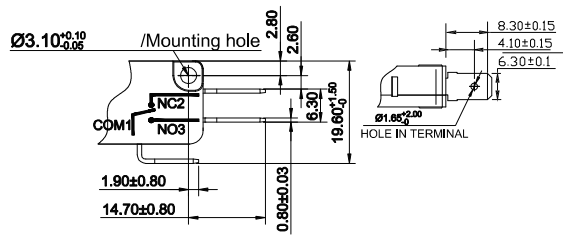

C2 Fully Flat Type Housing with 250# Quick Connect Terminals, T=0.8(C2)

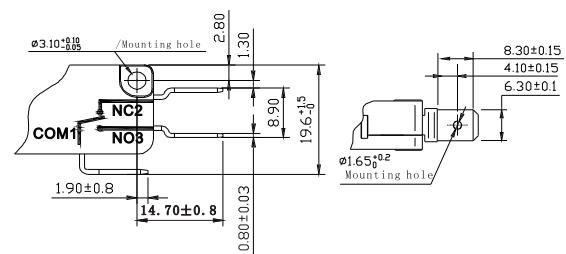

D2 Fully Flat Type Housing with 187# Quick Connect Terminals, T=0.8(D2)

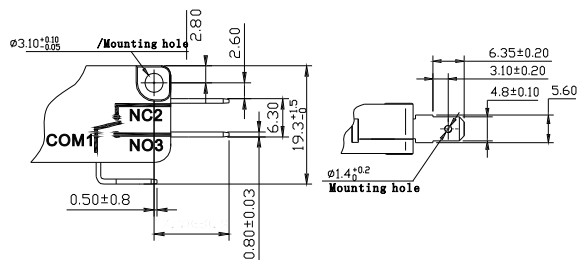

E2 Fully Flat Type Housing with 187# Quick Connect Terminals, T=0.5(E2)

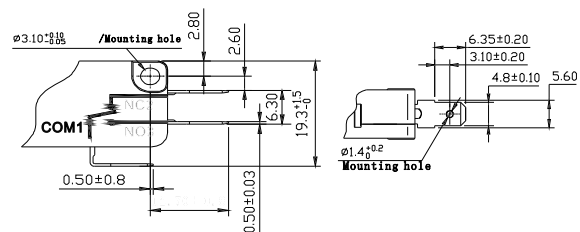

G5	T	16	C	Z	200	A	01	B	K	280
Switch Type	Temperature Grade	Electrical Rating	Terminal Type	Circuit Code	Max Operating Force at Pin Plunger	Lever Position	Lever Type	Housing Color	Mounting Holes	Special Designator

Terminal for Flat Type Housing

L Left Angled PCB Terminal	R Right Angled PCB Terminal	T Screw Terminal
-----------------------------------	------------------------------------	-------------------------

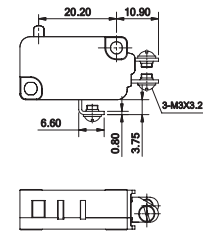
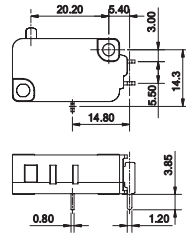
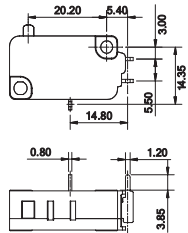

F Slant Screw Terminal	S Standard Solder Terminal	K Rectangle Hole Solder Terminal
-------------------------------	-----------------------------------	-----------------------------------------

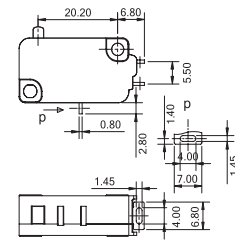
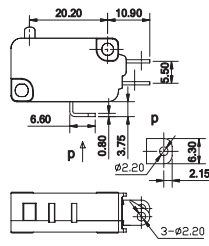
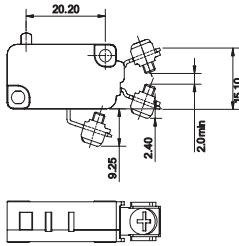

M Short Solder Terminal	-H RAST-5	-N RAST-7
--------------------------------	------------------	------------------

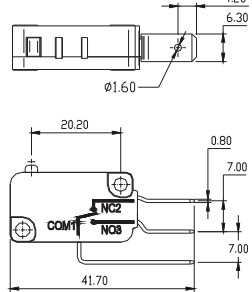
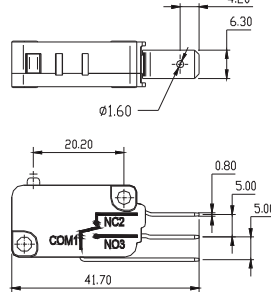
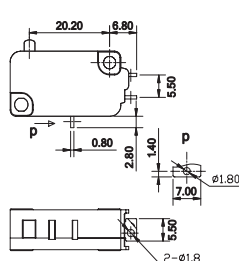

P Straight PCB Terminal	P Type Bended PCB Terminal	IP67 Water Proof and Dust Proof (Exclude Terminals)
--------------------------------	-----------------------------------	------------------------------------------------------------

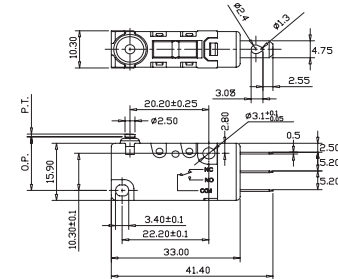
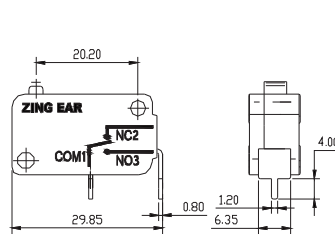
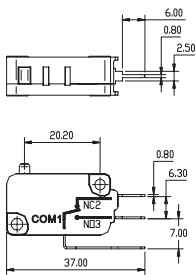

Circuit Configuration

Common Terminal Type	Z SPDT	C SPST-NC	P SPST-NO
----------------------	---------------	------------------	------------------

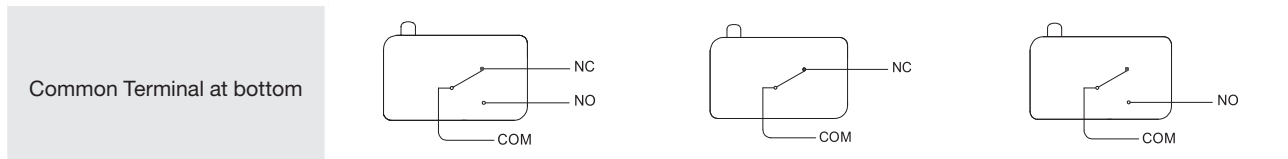

G5	T	16	C	Z	200	A	01	B	K	280
Switch Type	Temperature Grade	Electrical Rating	Terminal Type	Circuit Code	Max Operating Force at Pin Plunger	Lever Position	Lever Type	Housing Color	Mounting Holes	Special Designator

Max Operating Force at Pin Plunger

- 015 15gf**
Note: Only apply to G5S05, G5W11 (Rating1) series.
- 025 25gf**
Note: Only apply to G5S05, G5W11 (Rating1) series.
- 050 50gf**
0.49N
Note: Only apply to G5S05, G5W11 (Rating1 & Rating 2) series.
- 100 100gf**
0.98N
Note: 16A and 22A Minimum OF is 100gf.
- 200 200gf**
1.96N
Note: G5S05, G5T10, G5W11 Series
200gf/with maximum OF is 200gf
- 300 300gf**
2.94N
Note: Not apply to G5S05, G5T10, G5W11 Series.
- 400 400gf**
3.92N
Note: Not apply to G5S05, G5T10, G5W11 Series.
- 500 500gf**
4.90N
"B" Temperature grade only
- 1800 1800gf**
17.64N
"G5D Door switch" only

Other Levers

<p>08 Lever 08#</p>	<p>09 Lever 09#</p>	<p>137 Lever 137#</p>	<p>146 Lever 146#</p>
<p>152 Lever 152#</p>	<p>153 Lever 153#</p>	<p>165 Lever 165#</p>	<p>182 Lever 182#</p>

Lever Position

No lever
Pin Plunger

- A** Far From Pin Plunger
- B** Close to Pin Plunger
- F** Push Rod
G5D Door switch only
- J** Screw Push Rod
G5D Door switch only

Housing Color

Grey

- B** Black
- M** 750 °C
Glow Wire 750 °C

G5	T	16	C	Z	200	A	01	B	K	280
Switch Type	Temperature Grade	Electrical Rating	Terminal Type	Circuit Code	Max Operating Force at Pin Plunger	Lever Position	Lever Type	Housing Color	Mounting Holes	Special Designator

Lever Position

Metric \varnothing 3.1 mm

- K** \varnothing 2.9 mm
- U** Alloy base with inner mounting hole
Only for G5D Door Switch
- V** Alloy base with outer mounting hole
Only for G5D Door Switch
- W** Alloy base with two switches
Only for G5D Door Switch

Special Designator

Here means a special designator letter. Refer to products specification for detailed differences.

- H** Rast-5 250# terminal
- N** Rast-7 250# terminal
- P** Straight PCB Terminal
- A** Contact gold plated

Dimensions and Operating Characteristics

Pin Plunger

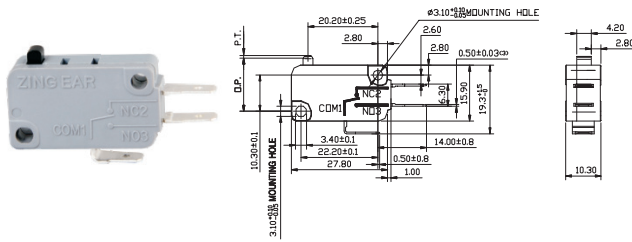

Part No.	Parameters							
	OF Max. (N)	OF Max. (gf)	RF Min. (N)	RF Min. (gf)	PT Max. (mm)	OT Min. (mm)	MD Max. (mm)	OP (mm)
G5□□□-E1Z015	0.15	15	0.03	3	1.6	0.8	0.4	14.7±0.5
G5□□□-E1Z025	0.25	25	0.05	5	1.6	0.8	0.4	14.7±0.5
G5□□□-E1Z050	0.49	50	0.10	10	1.6	0.8	0.4	14.7±0.5
G5□□□-E1Z100	0.98	100	0.25	25	1.6	0.8	0.4	14.7±0.5
G5□□□-E1Z200	1.96	200	0.49	50	1.6	0.8	0.4	14.7±0.5
G5□□□-E1Z300	2.94	300	0.74	75	1.6	0.8	0.4	14.7±0.5
G5□□□-E1Z400	3.92	400	0.98	100	1.6	0.8	0.4	14.7±0.5

01 Short Straight Lever

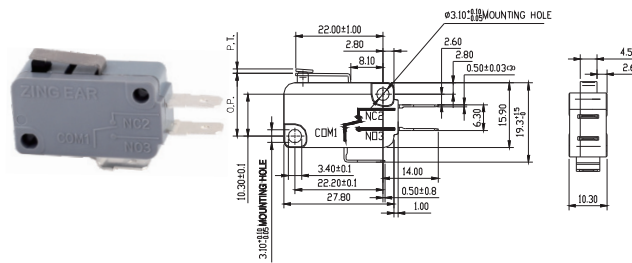

Part No.	Parameters							
	OF Max. (N)	OF Max. (gf)	RF Min. (N)	RF Min. (gf)	PT Max. (mm)	OT Min. (mm)	MD Max. (mm)	OP (mm)
G5□□□-E1Z015A01	0.15	15	0.03	3	1.6	0.8	0.4	15.3±0.5
G5□□□-E1Z025A01	0.25	25	0.05	5	1.6	0.8	0.4	15.3±0.5
G5□□□-E1Z050A01	0.49	50	0.10	10	1.6	0.8	0.4	15.3±0.5
G5□□□-E1Z100A01	0.98	100	0.25	25	1.6	0.8	0.4	15.3±0.5
G5□□□-E1Z200A01	1.96	200	0.49	50	1.6	0.8	0.4	15.3±0.5
G5□□□-E1Z300A01	2.94	300	0.74	75	1.6	0.8	0.4	15.3±0.5
G5□□□-E1Z400A01	3.92	400	0.98	100	1.6	0.8	0.4	15.3±0.5

02 Standard Straight Lever

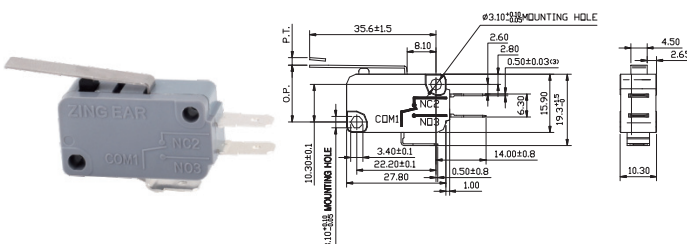

Part No.	Parameters							
	OF Max. (N)	OF Max. (gf)	RF Min. (N)	RF Min. (gf)	PT Max. (mm)	OT Min. (mm)	MD Max. (mm)	OP (mm)
G5□□□-E1Z015A02	0.15	15	0.03	2	3.2	1.3	1.2	15.3±1.5
G5□□□-E1Z025A02	0.25	25	0.05	2	3.2	1.3	1.2	15.3±1.5
G5□□□-E1Z050A02	0.49	50	0.10	5	3.2	1.3	1.2	15.3±1.5
G5□□□-E1Z100A02	0.98	100	0.25	10	3.2	1.3	1.2	15.3±1.5
G5□□□-E1Z200A02	1.96	200	0.49	20	3.2	1.3	1.2	15.3±1.5
G5□□□-E1Z300A02	2.94	300	0.74	30	3.2	1.3	1.2	15.3±1.5
G5□□□-E1Z400A02	3.92	400	0.98	40	3.2	1.3	1.2	15.3±1.5

03 Long Straight Lever

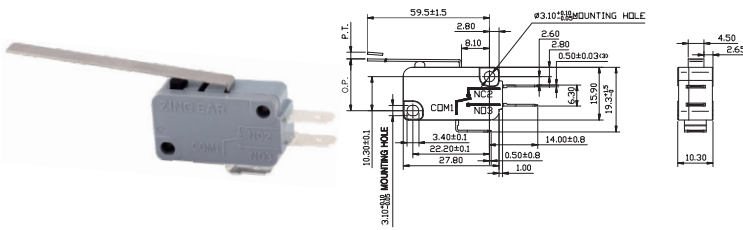

Part No.	Parameters							
	OF Max. (N)	RF Min. (gf)	PT Max. (mm)	OT Min. (mm)	MD Max. (mm)	OP (mm)		
G5□□□-E1Z015A03	0.07	7	0.02	2	6.4	2.6	2.4	15.3±3
G5□□□-E1Z025A03	0.10	10	0.02	2	6.4	2.6	2.4	15.3±3
G5□□□-E1Z050A03	0.15	15	0.02	2	6.4	2.6	2.4	15.3±3
G5□□□-E1Z100A03	0.29	30	0.05	5	6.4	2.6	2.4	15.3±3
G5□□□-E1Z200A03	0.59	60	0.10	10	6.4	2.6	2.4	15.3±3
G5□□□-E1Z300A03	0.88	90	0.15	15	6.4	2.6	2.4	15.3±3
G5□□□-E1Z400A03	1.18	120	0.20	20	6.4	2.6	2.4	15.3±3

05 Short Roller Lever

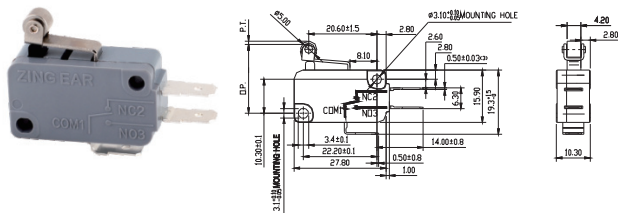

Part No.	Parameters							
	OF Max. (N)	RF Min. (gf)	PT Max. (mm)	OT Min. (mm)	MD Max. (mm)	OP (mm)		
G5□□□-E1Z015A05	0.15	15	0.03	3	1.6	0.8	0.4	20.6±0.8
G5□□□-E1Z025A05	0.30	30	0.05	5	1.6	0.8	0.4	20.6±0.8
G5□□□-E1Z050A05	0.59	60	0.10	10	1.6	0.8	0.4	20.6±0.8
G5□□□-E1Z100A05	1.18	120	0.20	20	1.6	0.8	0.4	20.6±0.8
G5□□□-E1Z200A05	2.35	240	0.39	40	1.6	0.8	0.4	20.6±0.8
G5□□□-E1Z300A05	3.43	350	0.59	60	1.6	0.8	0.4	20.6±0.8
G5□□□-E1Z400A05	4.60	470	0.78	80	1.6	0.8	0.4	20.6±0.8

06 Long Roller Lever

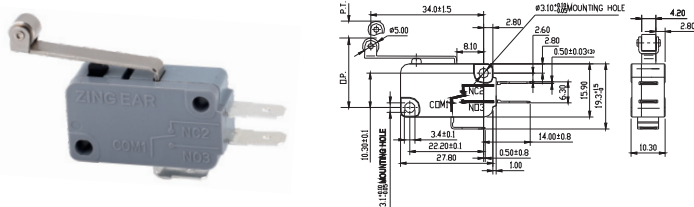

Part No.	Parameters							
	OF Max. (N)	RF Min. (gf)	PT Max. (mm)	OT Min. (mm)	MD Max. (mm)	OP (mm)		
G5□□□-E1Z015A06	0.10	10	0.02	2	3.2	1.3	1.2	20.6±1.6
G5□□□-E1Z025A06	0.15	15	0.02	2	3.2	1.3	1.2	20.6±1.6
G5□□□-E1Z050A06	0.29	30	0.05	5	3.2	1.3	1.2	20.6±1.6
G5□□□-E1Z100A06	0.59	60	0.10	10	3.2	1.3	1.2	20.6±1.6
G5□□□-E1Z200A06	1.18	120	0.20	20	3.2	1.3	1.2	20.6±1.6
G5□□□-E1Z300A06	1.77	180	0.29	30	3.2	1.3	1.2	20.6±1.6
G5□□□-E1Z400A06	2.35	240	0.39	40	3.2	1.3	1.2	20.6±1.6

Pin Plunger, 250# Terminals

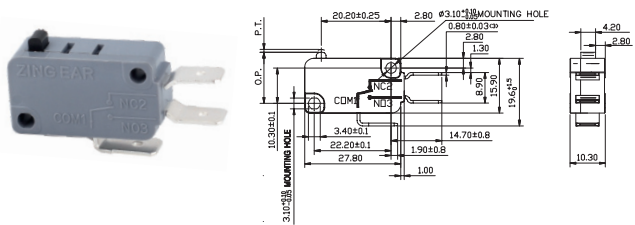

Part No.	Parameters							
	OF Max. (N)	RF Min. (gf)	PT Max. (mm)	OT Min. (mm)	MD Max. (mm)	OP (mm)		
G5□□□-C1Z015	0.15	15	0.03	3	1.6	0.8	0.4	14.7±0.5
G5□□□-C1Z025	0.25	25	0.05	5	1.6	0.8	0.4	14.7±0.5
G5□□□-C1Z050	0.49	50	0.10	10	1.6	0.8	0.4	14.7±0.5
G5□□□-C1Z100	0.98	100	0.25	25	1.6	0.8	0.4	14.7±0.5
G5□□□-C1Z200	1.96	200	0.49	50	1.6	0.8	0.4	14.7±0.5
G5□□□-C1Z300	2.94	300	0.74	75	1.6	0.8	0.4	14.7±0.5
G5□□□-C1Z400	3.92	400	0.98	100	1.6	0.8	0.4	14.7±0.5

Pin Plunger Basic Type Housing, 250# Terminals

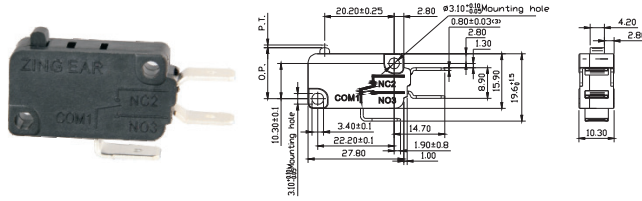

Part No.	Parameters							
	OF Max. (N)	OF (gf)	RF Min. (N)	RF (gf)	PT Max. (mm)	OT Min. (mm)	MD Max. (mm)	OP (mm)
G5□□□-CZ015	0.15	15	0.03	3	1.6	0.8	0.4	14.7±0.5
G5□□□-CZ025	0.25	25	0.05	5	1.6	0.8	0.4	14.7±0.5
G5□□□-CZ050	0.49	50	0.10	10	1.6	0.8	0.4	14.7±0.5
G5□□□-CZ100	0.98	100	0.25	25	1.6	0.8	0.4	14.7±0.5
G5□□□-CZ200	1.96	200	0.49	50	1.6	0.8	0.4	14.7±0.5
G5□□□-CZ300	2.94	300	0.74	75	1.6	0.8	0.4	14.7±0.5
G5□□□-CZ400	3.92	400	0.98	100	1.6	0.8	0.4	14.7±0.5

Pin Plunger Basic Type Housing, 187# Terminals

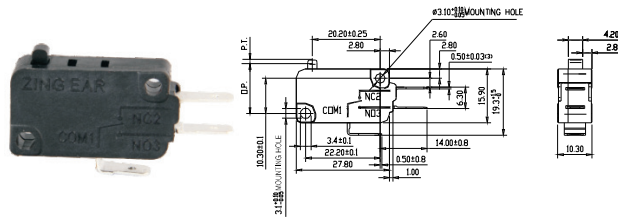

Part No.	Parameters							
	OF Max. (N)	OF (gf)	RF Min. (N)	RF (gf)	PT Max. (mm)	OT Min. (mm)	MD Max. (mm)	OP (mm)
G5□□□-EZ015	0.15	15	0.03	3	1.6	0.8	0.4	14.7±0.5
G5□□□-EZ025	0.25	25	0.05	5	1.6	0.8	0.4	14.7±0.5
G5□□□-EZ050	0.49	50	0.10	10	1.6	0.8	0.4	14.7±0.5
G5□□□-EZ100	0.98	100	0.25	25	1.6	0.8	0.4	14.7±0.5
G5□□□-EZ200	1.96	200	0.49	50	1.6	0.8	0.4	14.7±0.5
G5□□□-EZ300	2.94	300	0.74	75	1.6	0.8	0.4	14.7±0.5
G5□□□-EZ400	3.92	400	0.98	100	1.6	0.8	0.4	14.7±0.5

IP64 Waterproof switch

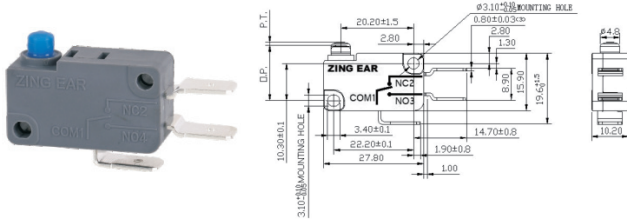

Part No.	Parameters							
	OF Max. (N)	OF (gf)	RF Min. (N)	RF (gf)	PT Max. (mm)	OT Min. (mm)	MD Max. (mm)	OP (mm)
G5F**-C1Z300	2.94	300	0.74	75	1.6	0.8	0.4	14.7±0.5

04 Simulated Roller Lever

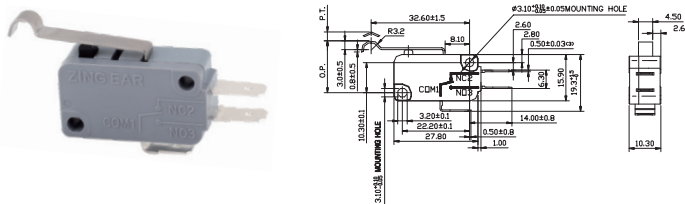

Part No.	Parameters							
	OF Max. (N)	OF (gf)	RF Min. (N)	RF (gf)	PT Max. (mm)	OT Min. (mm)	MD Max. (mm)	OP (mm)
G5□□□-E1Z015A04	0.10	10	0.02	2	3.2	1.3	1.2	18.3±1.5
G5□□□-E1Z025A04	0.15	15	0.02	2	3.2	1.3	1.2	18.3±1.5
G5□□□-E1Z050A04	0.29	30	0.02	2	3.2	1.3	1.2	18.3±1.5
G5□□□-E1Z100A04	0.59	60	0.10	10	3.2	1.3	1.2	18.3±1.5
G5□□□-E1Z200A04	1.18	120	0.20	20	3.2	1.3	1.2	18.3±1.5
G5□□□-E1Z300A04	1.77	180	0.30	30	3.2	1.3	1.2	18.3±1.5
G5□□□-E1Z400A04	2.35	240	0.39	40	3.2	1.3	1.2	18.3±1.5

G5W11 Series

Waterproof Micro Switch

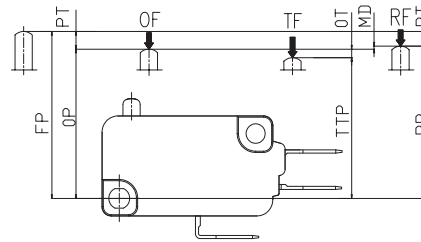
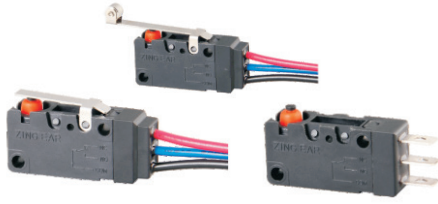

Features

- Water Proof and Dust Proof
- Tight Structure, Small Contact Gap
Snap Action, High Sensitivity
- Long Life, high Precision and Reliability
- Widely used in Auto, Agricultural Equipment, Applications, Office Equipment etc
- Max Approved Current at ENEC/UL is 10A

Applications

- Home Appliances
- Electronic Devices
- Automatic Equipments
- Auto Electronics
- Agricultural Equipments
- Office Equipments

Parameters

Rating	W1	ENEC 0.1A 48VDC, 0.1A 125/250VAC, 40T85, 5E4, μ UL 0.1A 48VDC, 0.1A 125/250VAC, T85
	W2	ENEC- 5A 125/250VAC, 5A, 30VDC, 40T85, 5E4, μ UL: 5A 125/250VAC, 5A 30VDC T85
	W3	ENEC 10(2)A 125/250VAC, 0.5A 125VDC, 0.25A 250VDC, 40T85, u, 2E4 UL 10.1A 1/10HP 125/250VAC, 0.5A 125VDC, 0.25A 250VDC, T85
Operating Frequency	Electrical	10-30 times/min
	Mechanical	60 times/min
Contact Resistance	With Terminal Type	50m Ω Max
	With Wire Type	100m Ω Max (Depends on the length of the wire)
Insulation Resistance		at 500VDC, 100M Ω Min.
Dielectric Strength	Between terminals	AC 1000V 50-60Hz 1 min
	Between terminals and housing	AC 1500V 50-60Hz 1 min
Storage Temperature		-40°C ~ +85°C
Storage Humidity		85% RH Max
Protection Grade	With Terminal Type	IEC IP67 (exclude terminal)
	With Wire Type	IEC IP67
Electric-shock safeguard grade		Class II
PTI		250
Life	E-life	2E4-10E4 cycles (depends on P/Ns)
	M-life	over 500,000 cycles or 1,000,000 cycles (60 cycles/min)
Unit Net Weight		Approx. 7g (with terminal type and without lever)

G5	W	11	C	Z	200	A	01	XX
Switch Type	Temperature grade	Electrical Rating	Terminal Style	Circuit Code	Max Operating Force at Pin Plunger	Lever Position	Lever Type	Special Designator
	W 40T85 IEC IP67	ENEC/CQC: Rating 1: 0.1 A 48 VDC, 0.1 A 125/250VAC, 40T85, 5E4, μ Rating 2: 5 A 125/250VAC 5 A 30 VDC, 40T85, 5E4, μ Rating 3: 10(2) A 125/250VAC; 0.5 A 125 VDC; 0.25A 250 VDC, 40T85, μ , 2E4 UL/CUL: Rating 1: 0.1 A 48 VDC 0.1 A 125/250VAC, T85 Rating2: 5 A 125/250VAC, T85 Rating3: 10.1 A 1/10HP 125/250VAC, 0.5 A 125 VDC, 0.25A 250 VDC, T85	E 4.70x0.5 mm 0.187"x0.020" Quick Connect W For G5W11 series only	Z DSPDT P SPST-NO C SPST-NC	015 15gf 025 25gf 050 50gf 100 100gf 200 200gf	No Lever Pin Plunger A Far From Pin Plunger B Near Pin Plunger	No Lever Pin Plunger 01 Short Straight Lever 02 Std. Straight Lever 03 Straight Lever 04 Simulated Roller Lever 05 Roller Lever 06 Long Roller Lever ... 99 Special Lever	W1 Rating 1 (Note: standard wire: UL1015, 24#, 300mm) W2 Rating 2 (Note: standard wire: UL1015, 20#, 300mm) W3 Rating 3 (Note: standard wire: UL1015, 18#, 300mm) ... Special

Description

G5W11 (rating 2)- 50gf Min. Grade
G5W11 (rating 3)- 100gf Min. Grade

Dimensions and Operating Characteristics

G5W11-E□□-W□



Part No.	OF Max. (N)	RF Min. (gf)	PT Max. (N)	OT Min. (gf)	MD Max. (mm)	OP Max. (mm)	OP (mm)	
G5W11-EZ015-W□	0.30	30	0.05	5	1.6	0.8	0.4	14.7±0.5
G5W11-EZ025-W□	0.40	40	0.10	10	1.6	0.8	0.4	14.7±0.5
G5W11-EZ050-W□	0.64	65	0.15	15	1.6	0.8	0.4	14.7±0.5
G5W11-EZ100-W□	1.08	110	0.35	35	1.6	0.8	0.4	14.7±0.5
G5W11-EZ200-W□	2.06	210	0.6	60	1.6	0.8	0.4	14.7±0.5

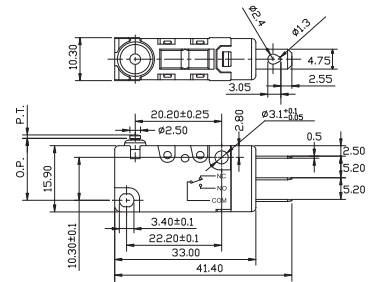

G5W11-W□□-W□



Part No.	OF Max. (N)	RF Min. (gf)	PT Max. (N)	OT Min. (gf)	MD Max. (mm)	OP Max. (mm)	OP (mm)	
G5W11-WZ015-W□	0.30	30	0.05	5	1.6	0.8	0.4	14.7±0.5
G5W11-WZ025-W□	0.40	40	0.10	10	1.6	0.8	0.4	14.7±0.5
G5W11-WZ050-W□	0.64	65	0.15	15	1.6	0.8	0.4	14.7±0.5
G5W11-WZ100-W□	1.08	110	0.35	35	1.6	0.8	0.4	14.7±0.5
G5W11-WZ200-W□	2.06	210	0.6	60	1.6	0.8	0.4	14.7±0.5

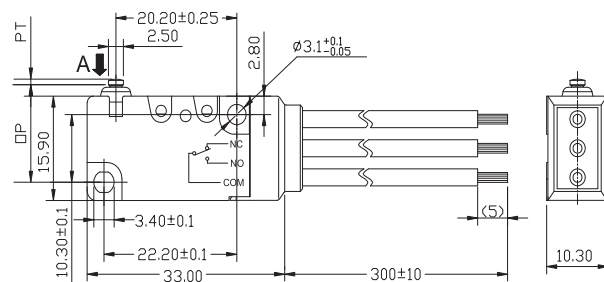

G5W11-W□□A01-W□



Part No.	OF Max. (N)	OF Max. (gf)	RF Min. (N)	RF Min. (gf)	PT Max. (mm)	PT Min. (mm)	MD Max. (mm)	OP (mm)
G5W11-WZ015A01-W□	0.30	30	0.05	5	1.6	0.8	0.4	15.3±0.5
G5W11-WZ025A01-W□	0.40	40	0.10	10	1.6	0.8	0.4	15.3±0.5
G5W11-WZ050A01-W□	0.64	65	0.15	15	1.6	0.8	0.4	15.3±0.5
G5W11-WZ100A01-W□	1.08	110	0.35	35	1.6	0.8	0.4	15.3±0.5
G5W11-WZ200A01-W□	2.06	210	0.59	60	1.6	0.8	0.4	15.3±0.5

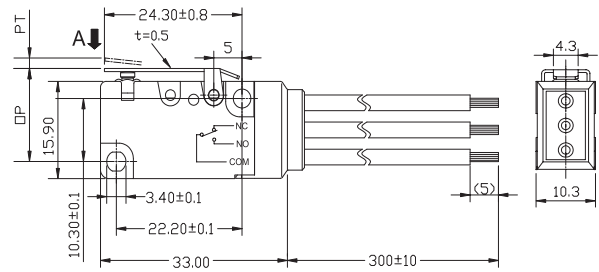

G5W11-W□□A02-W□

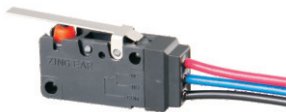

Part No.	OF Max. (N)	OF Max. (gf)	RF Min. (N)	RF Min. (gf)	PT Max. (mm)	PT Min. (mm)	MD Max. (mm)	OP (mm)
G5W11-WZ015A02-W□	0.20	20	0.05	5	3.2	1.3	1.2	15.3±1.5
G5W11-WZ025A02-W□	0.25	25	0.08	8	3.2	1.3	1.2	15.3±1.5
G5W11-WZ050A02-W□	0.40	40	0.15	15	3.2	1.3	1.2	15.3±1.5
G5W11-WZ100A02-W□	0.64	65	0.25	25	3.2	1.3	1.2	15.3±1.5
G5W11-WZ200A02-W□	1.27	130	0.35	35	3.2	1.3	1.2	15.3±1.5

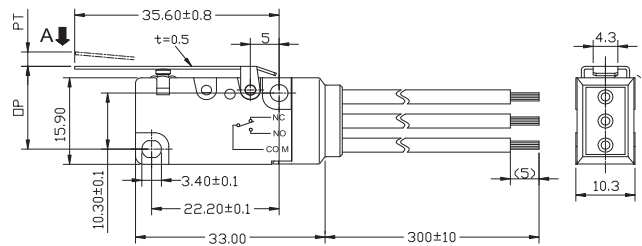

G5W11-W□□A03-W□



Part No.	OF Max. (N)	OF Max. (gf)	RF Min. (N)	RF Min. (gf)	PT Max. (mm)	PT Min. (mm)	MD Max. (mm)	OP (mm)
G5W11-WZ015A03-W□	0.10	10	0.03	3	6.4	2.6	2.4	15.3±3
G5W11-WZ025A03-W□	0.15	15	0.05	5	6.4	2.6	2.4	15.3±3
G5W11-WZ050A03-W□	0.20	20	0.08	8	6.4	2.6	2.4	15.3±3
G5W11-WZ100A03-W□	0.35	35	0.10	10	6.4	2.6	2.4	15.3±3
G5W11-WZ200A03-W□	0.64	65	0.15	15	6.4	2.6	2.4	15.3±3

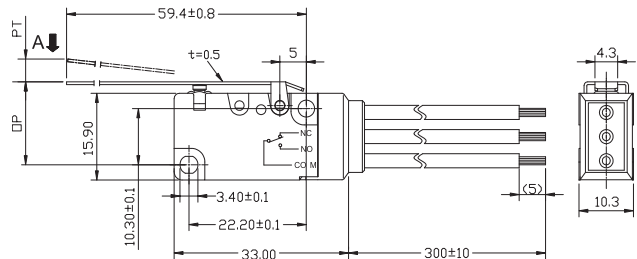

G5W11-W□□A04-W□



Part No.	OF Max. (N)	OF Max. (gf)	RF Min. (N)	RF Min. (gf)	PT Max. (mm)	PT Min. (mm)	MD Max. (mm)	OP (mm)
G5W11-WZ015A04-W□	0.20	20	0.05	5	3.2	1.3	1.2	18.5±1.5
G5W11-WZ025A04-W□	0.25	25	0.08	8	3.2	1.3	1.2	18.5±1.5
G5W11-WZ050A04-W□	0.40	40	0.15	15	3.2	1.3	1.2	18.5±1.5
G5W11-WZ100A04-W□	0.64	65	0.25	25	3.2	1.3	1.2	18.5±1.5
G5W11-WZ200A04-W□	1.27	130	0.35	35	3.2	1.3	1.2	18.5±1.5

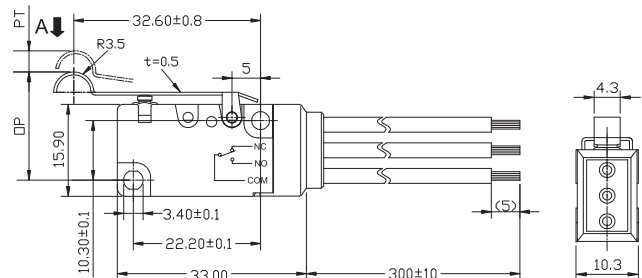

G5W11-W□□A05-W□

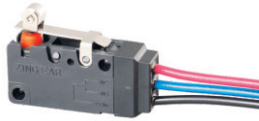

Part No.	OF		RF		PT	OT	MD	OP
	Max. (N)	(gf)	Min. (N)	(gf)	Max. (mm)	Min. (mm)	Max. (mm)	(mm)
G5W11-WZ015A05-W□	0.30	30	0.05	5	3.2	0.8	0.4	20.6±0.8
G5W11-WZ025A05-W□	0.40	40	0.10	10	3.2	0.8	0.4	20.6±0.8
G5W11-WZ050A05-W□	0.64	65	0.15	15	3.2	0.8	0.4	20.6±0.8
G5W11-WZ100A05-W□	1.18	120	0.35	35	3.2	0.8	0.4	20.6±0.8
G5W11-WZ200A05-W□	2.35	240	0.59	60	3.2	0.8	0.4	20.6±0.8

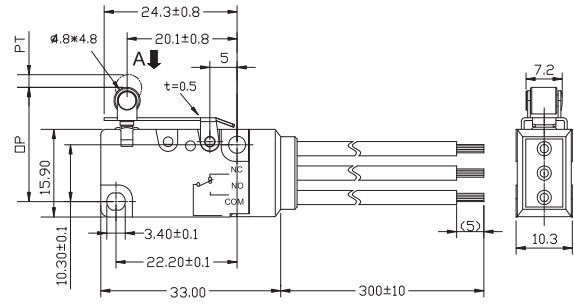

G5W11-W□□A06-W□



Part No.	OF		RF		PT	OT	MD	OP
	Max. (N)	(gf)	Min. (N)	(gf)	Max. (mm)	Min. (mm)	Max. (mm)	(mm)
G5W11-WZ015A06-W□	0.20	20	0.05	5	3.2	1.3	1.2	20.6±1.6
G5W11-WZ025A06-W□	0.25	25	0.08	8	3.2	1.3	1.2	20.6±1.6
G5W11-WZ050A06-W□	0.40	40	0.15	15	3.2	1.3	1.2	20.6±1.6
G5W11-WZ100A06-W□	0.64	65	0.25	25	3.2	1.3	1.2	20.6±1.6
G5W11-WZ200A06-W□	1.27	130	0.35	35	3.2	1.3	1.2	20.6±1.6

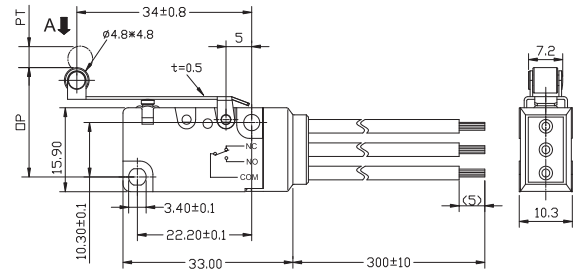

G6 Series

Miniature Micro Switch

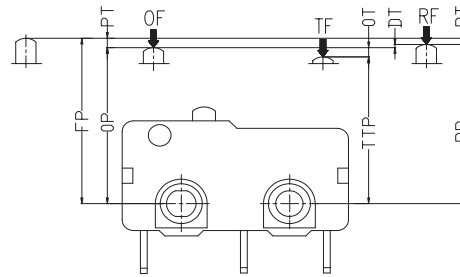

Features

- Small Compact Size
- Global Safety Approvals
- Long Life and High Reliability
- Variety of Actuator and Terminals
- High Rating to 10(2)A, 1/4HP
- Customized Designs
- Widely used in Auto Control, Appliance Control, Industrial Control etc.

Applications

- Phone
- Air-Conditioner
- Computer
- Humidifier
- Alarm
- Timer
- Mixer&Meat Grinder
- Welding Machine
- Neon Phone
- Fax Machine
- Game Controller
- Pencil Sharpener
- Money Sorter
- Food Processor
- Electric Knife
- Toy Car
- Juice Extractor
- Lighting Equipment
- Electric Frying pan

Parameters

Rating	P1/P11/P12	ENEC 0.1A 125/250V 48VDC 5E4 UL: 0.1A 125/250VAC 48VDC Gold Plated Contact Optional
	05/051/052	ENEC 5A 125/250VAC 5(3)A 125/250VAC 5A 30VDC UL: 5A 1/8HP 125/250VAC
	10/101	ENEC 10(2)A 125/250VAC μ 25T125 UL: 10.1A 1/4HP 125/250VAC
	12	ENEC: 12 (6) A 125/250VAC μ 40T125 UL: 12A 125/250VAC Only with 350gf OF
Operating Frequency	Electrical	10-30 cycles/min.
	Mechanical	120 cycles/min.
Contact Resistance (Initiative)		100M Ω Max
Insulation Resistance (at 500VDC)		100M Ω Min.
Dielectric Strength		AC 1000V RMS (50-60Hz)
Storage Temperature		-25°C ~ +125° C
Storage Humidity		85% RH Max
Service Life	Electrical	1,000 - 50,000 cycles (Depend on part No.)
	Mechanical	1,000,000 cycles

G6	05	150	S	00	A	A	XX
Switch Type	Electrical Rating	Max Operating Force at Pin Plunger	Terminal Type	Lever Type	Circuit Code	Special Designator	Special Designator
G6 Series Micro Switch	P1 ENEC/CQC: 0.1A 125/250VAC 48VDC 5E4 μ 25T125 UL 0.1A 125/250VAC 48VDC Gold plated contact optional	50 50gf 0.49 N (Only for 0.1A rating)	S Solder Terminals	00 No Lever Pin Plunger	A SPDT	General	Here means a special designator letter. Refer to Products Specification for detailed differences.
	05 ENEC/CQC: 5A 125/250VAC 30VDC 5E4 μ 25T125 UL 5A 1/8HP 125/250VAC 30VDC	100 100gf 0.98 N (Only for 0.1A and 5A rating)	P Straight PCB Terminals	01 16.7 mm Short Straight Lever 0.66"	B SPST-NC	A Gold Plated Contacts (Optional, only for G6P1)	
	10 ENEC/CQC: 10(2)A 125/250VAC μ 25T125 UL 10.1A 1/4HP 125/250VAC	150 150gf 1.49 N (Note: For G6P11, G6051, G6101, Max. OF is 150gf)	R Right side PCB Terminals (Note: Only available for G6P1, G605, G610)	02 18.7 mm Standard Straight Lever 0.74"	C SPST-NO	D High DC Rating Special use	
	12 ENEC/CQC: 12(6)A 125/250VAC μ 25T125 UL 12A 125/250VAC	250 250gf 2.45 N (Note: Only available for G6P1, G605, G610)	L Right side PCB Terminals (Note: Only available for G6P1, G605, G610)	03 Long Straight Lever 0.98"		... Other	
	P11 ENEC/CQC: 0.1A 125/250VAC 48VDC 5E4 μ 25T125 UL 0.1A 125/250VAC 48VDC Gold plated contact optional Spring plate type	350 350gf 3.43 N Mainly for G612	D 110# 2.80x0.6 mm quick connect Terminals 0.11"x0.023"	04 35.1 mm Long Straight Lever 1.39"			
	051 ENEC/CQC: 5A 125/250VAC 5E4 μ 25T125 UL 5A 1/8HP 125/250VAC Spring plate type	F Special OF	E 110# 2.80x0.5 mm quick connect Terminals 0.11"x0.023"	05 18.0 mm Std. Simulated Roller Lever 0.71"			
	101 ENEC/CQC: 10(2)A 125/250VAC μ 25T125 UL 10.1A 1/4HP 125/250VAC Note:Switch with "10"rating are only available with "150"OF Spring plate type		... Special Terminals	06 16.6 mm Roller Lever 0.65"			
	P12 ENEC/CQC: 0.1A 125/250VAC 48VDC 5E4 μ 25T85 UL 0.1A 125/250VAC 48VDC Gold plated contact optional Bakelite Spring plate type			07 17.9 mm Small Simulated Roller Lever 0.71"			
	052 ENEC/CQC: 5A 125/250VAC 5E4 μ 25T85 UL 5A 1/8HP 125/250VAC Bakelite housing Spring plate type			09 Plastic Roller Lever			
				... Other			

Mounting Hole Dimensions

Solder and 110# Terminal

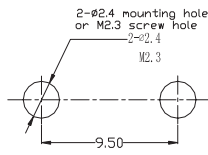

Straight PCB Terminal

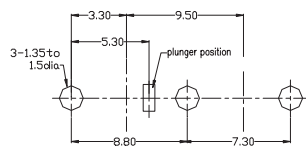

Right Angled PCB Terminal

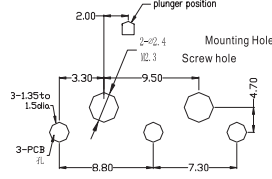

Left Angled PCB Terminal

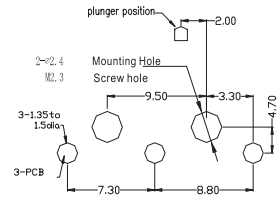

Circuit Configuration

A SPDT

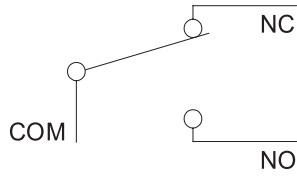

B SPST-NC

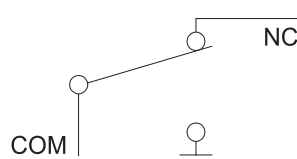

C SPST-NO

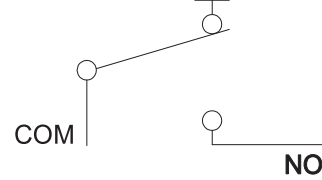

Terminal Dimensions

Solder Terminals

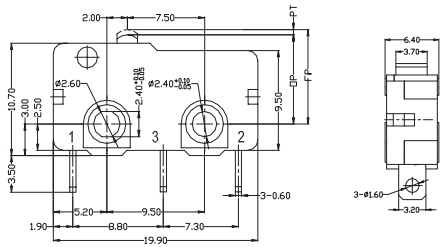

Straight PCB Terminals

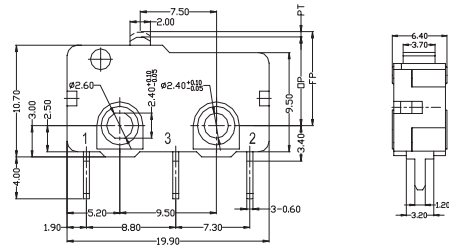

Quick Connect Terminals (Thickness: 0.6 mm)

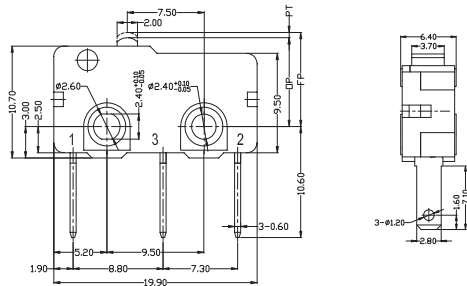

Quick Connect Terminals (Thickness: 0.5 mm)

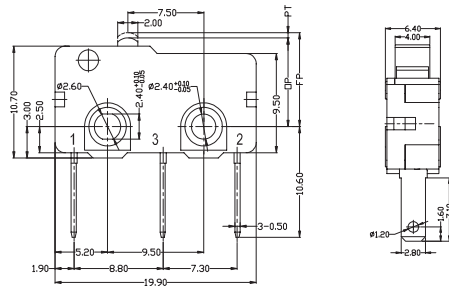

Left Angled PCB Terminals

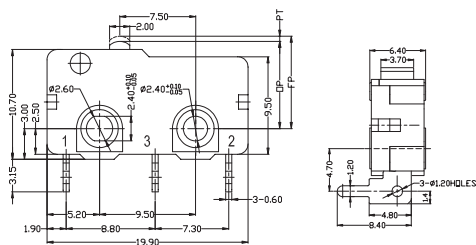

Right Angled PCB Terminals

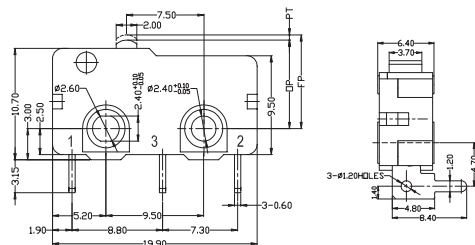

Dimensions and Operating Characteristics

G6□□-□□□S00A

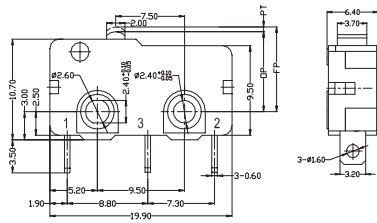

OF Max. (gf)	RF Min. (gf)	PT Max. (mm)	OT Min. (mm)	DT Max. (mm)	FP Max. (mm)	OP (mm)	
-100	100	10	1.0	0.4	0.2	9.1	8.5±0.3
-150	150	35	1.0	0.4	0.2	9.1	8.5±0.3
-250	250	50	1.0	0.4	0.2	9.1	8.5±0.3
-350	350	80	1.0	0.4	0.2	9.1	8.5±0.3

G6□□-□□□S00A-B3

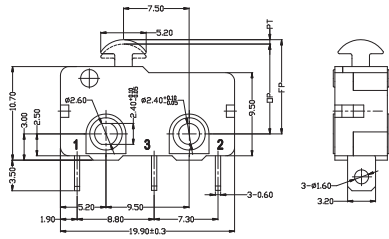

OF Max. (gf)	RF Min. (gf)	PT Max. (mm)	OT Min. (mm)	DT Max. (mm)	FP Max. (mm)	OP (mm)	
-100	100	10	1.0	0.4	0.2	10.9	10.3±0.3
-150	150	35	1.0	0.4	0.2	10.9	10.3±0.3
-250	250	50	1.0	0.4	0.2	10.9	10.3±0.3

G6□□-□□□S01A

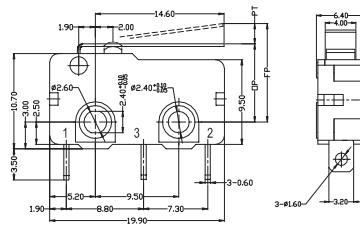

OF Max. (gf)	RF Min. (gf)	PT Max. (mm)	OT Min. (mm)	DT Max. (mm)	FP Max. (mm)	OP (mm)	
-100	40	6	3.6	0.6	1.0	11.7	8.9±1.0
-150	50	8	3.6	0.6	1.0	11.7	8.9±1.0
-250	80	15	3.6	0.6	1.0	11.7	8.9±1.0
-350	110	30	3.6	0.6	1.0	11.7	8.9±1.0

G6□□-□□□S02A

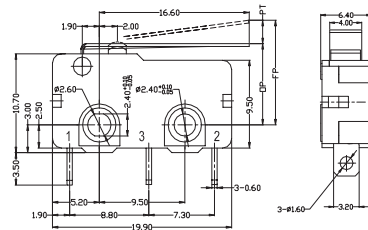
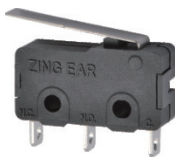

OF Max. (gf)	RF Min. (gf)	PT Max. (mm)	OT Min. (mm)	DT Max. (mm)	FP Max. (mm)	OP (mm)	
-100	35	5	4.0	0.6	1.0	12.0	8.9±1.2
-150	45	6	4.0	0.6	1.0	12.0	8.9±1.2
-250	75	10	4.0	0.6	1.0	12.0	8.9±1.2
-350	110	30	4.0	0.6	1.0	12.0	8.9±1.2

G6□□-□□□S03A

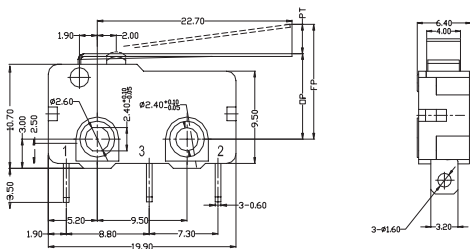

OF Max. (gf)	RF Min. (gf)	PT Max. (mm)	OT Min. (mm)	DT Max. (mm)	FP Max. (mm)	OP (mm)	
-100	25	2	6.1	0.8	1.8	13.5	8.9±1.8
-150	35	6	6.1	0.8	1.8	13.5	8.9±1.8
-250	55	10	6.1	0.8	1.8	13.5	8.9±1.8

G6□□-□□□S04A

G6 Miniature Micro Switch

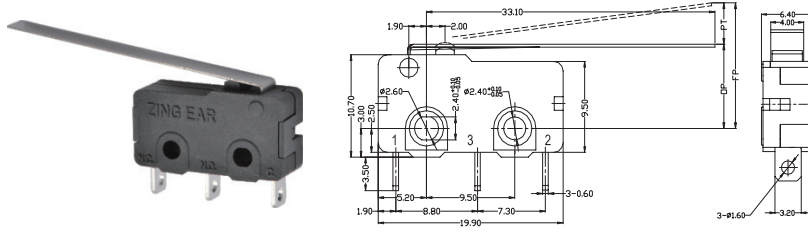

OF Max. (gf)	RF Min. (gf)	PT Max. (mm)	OT Min. (mm)	DT Max. (mm)	FP Max. (mm)	OP (mm)	
-100	15	2	7.5	1.5	2	15.5	8.9±2.0
-150	30	4	7.5	1.5	2.0	15.5	8.9±2.0
-250	45	7	7.5	1.5	2.0	15.5	8.9±2.0
-350	350	80	1.0	0.4	0.2	9.1	8.5±0.3

G6□□-□□□S05A

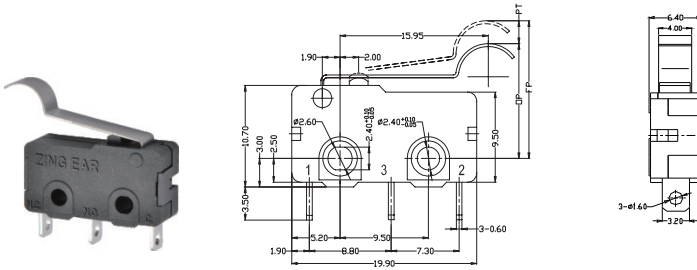

OF Max. (gf)	RF Min. (gf)	PT Max. (mm)	OT Min. (mm)	DT Max. (mm)	FP Max. (mm)	OP (mm)	
-100	35	5	5.0	0.6	1.0	18.5	12.2±1.5
-150	45	6	5.0	0.6	1.0	18.5	12.2±1.5
-250	75	10	5.0	0.6	1.0	18.5	12.2±1.5
-350	100	20	5.0	0.6	1.0	18.5	12.2±1.5

G6□□-□□□S06A

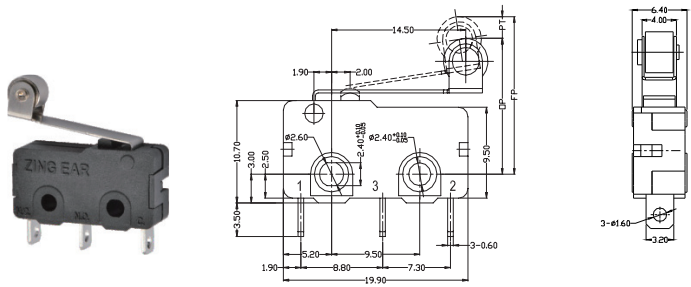

OF Max. (gf)	RF Min. (gf)	PT Max. (mm)	OT Min. (mm)	DT Max. (mm)	FP Max. (mm)	OP (mm)	
-100	40	6	3.8	0.8	1.0	17.6	14.6±1.0
-150	50	8	3.8	0.8	1.0	17.6	14.6±1.0
-250	80	15	3.8	0.8	1.0	17.6	14.6±1.0
-350	110	30	3.8	0.8	1.0	17.6	14.6±1.0

G6□□-□□□S07A

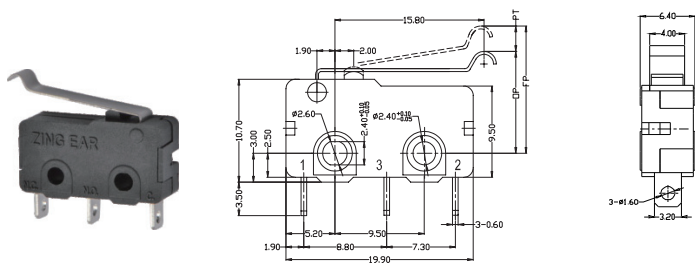

OF Max. (gf)	RF Min. (gf)	PT Max. (mm)	OT Min. (mm)	DT Max. (mm)	FP Max. (mm)	OP (mm)	
-100	40	6	4.5	0.8	1.0	14.4	10.8±1.2
-150	50	8	4.5	0.8	1.0	14.4	10.8±1.2
-250	80	15	4.5	0.8	1.0	14.4	10.8±1.2
-350	110	20	4.5	0.8	1.0	14.4	10.8±1.2

G9 Series

Micro Switch Ordering Instruction

G9 series

G9	05	200	S	00
Switch Type	Electrical Rating	MaxOperating Force at pin Plunger	Terminal Style	Lever Type
G9 Series Micro-Switch	P1 ENEC/CQC: 0.1A 125/250VAC 48 VDC 5E4 μ 25T120 UL/CUL: 0.1A 125/250VAC 48VDC (Gold Plated Contact optional) Only for letter s and p	150 150gf Max. (Only for G9P1)	S Solder Terminals	00 Spherical Pin Plunger
	05 ENEC/CQC: 6A 125/250VAC 1E4; μ 3A 125/250VAC 30VDC 5E4 UL/CUL: 5A 125/250VAC Only for letter s and p	200 200gf Max.	P Straight PCB Terminals (0.6mm wide)	01 Short Straight Lever 17.7mm (0.70")
		300 300gf Max.	D 110# Quick Connect Terminals (2.8X0.5mm)	02 Std. Straight Lever 19.7mm (0.78")
			E Wires leads to bottom (500mm)	03 Long Straight Lever 25.8mm (1.02")
			F Wires leads to side (500mm) (opposite to plunger)	05 Small Simulated Roller Lever 18.9mm (0.75")
			G Wires leads to side (500mm) (plunger side)	06 Roller Lever 15.7mm (0.62")
			... Special Terminals	07 Small Simulated Roller Lever 19.0mm
				12 Long Straight Lever 56.2mm (2.23")
				... Other

D	1	A	XXX	XXX	XXX
Costruction	Circuit Code	Special Designator	AWG Type (for Wire type only)	AWG Number (for Wire type only)	Wires lenght
D Dust proof -IP00 No wire	1 SPDT	General Temperature grade 25T120	20#	UL1007	Standard lenght: 500mm
W Water tight-IP67 With lead wires	2 SPST - NC	A Gold Plated Contacts (Optional Only for G9P1)	F 22#	B UL1569	
	3 SPST - NO	D Special use for high DC ratig	G 24#	C UL1430	
		B Lever Can Be On Two Sides (opposite to plunger)	H 26#	D UL1061	
		C Lever Can Be On Two Sides (plunger side)	M 28#	E UL1330	
		E Lever Can Be On Two Sides (No Lever)		F AVSS	
		... Other		G UL3266	
				H UL1332	
				K UL1015	

G9	03	130	S	00	A	2	A	XXX	XXX	XXX
Switch Type	Electrical Rating	Operating Force at pin Plunger Max	Terminal Style	Lever Type	Circuit Code	Shape and Posts	Posts Dimension	AWG Type (for Wire type only)	AWG Number (for Wire type only)	Wires length

G9 Series

Sealed Mini Micro Switch

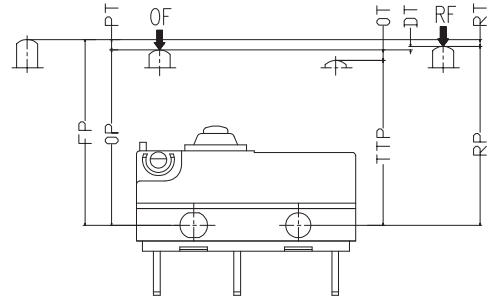
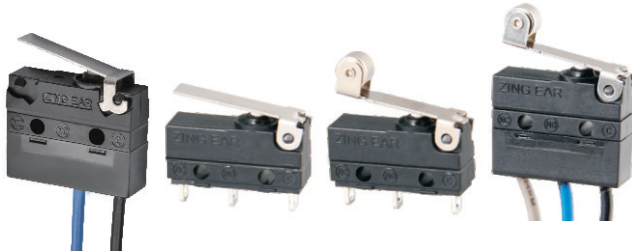

Features

- Dust and Water Proof(IP67)Design
- Small Compact Size
- Long Life,High Reliability
- Variety of Terminals and Levers
- Widely used in Auto Control, Appliance and other Industry Control

- Alarm
- Timer
- Mixer&Meat Grinder
- Welding Machine
- Neon Phone
- Fax Machine
- Game Controller
- Pump
- Gas Detector
- Pencil Sharpener
- Money Sorter
- Food Processor
- Electric Knife
- Toy Car
- Juice Extractor
- Lighting Equipment
- Electric Frying Pan

Applications

- Car
- Phone
- Air-Conditioner
- Computer
- Humidifier

Parameters

Rating	P1	0.1A 125/250VAC 48VDC Gold Plated Contact Optional
	05	UL: 5A 125/250VAC ENEC: 6A 125/250VAC 1E4; 3A 125/250VAC 30VDC 5E4 μ25T120
Operating Frequency	Electrical	10~30 cycles/minute
	Mechanical	120 cycles/minute
Contact Resistance (Initiative)	100mΩ Max (It depends on the wire length for the type with wire)	
Insulation Resistance (at 500VDC)	100mΩ Min	
Dielectric Strenght	AC 1,000V RMS (50~60Hz)	
Storage Temperature	-25°C ~ +120°C	
Storage Humidity	85%RHMax	
Service Life	Electrical	10,000 ~ 100,000 cycles (Depend on part No.)
	Mechanical	500,000 cycles

G9	05	200	S	00	D	1	A	XXX	XXX	XXX
Switch Type	Electrical Rating	Max Operating Force at pin Plunger	Terminal Style	Lever Type	Costruction	Circuit Code	Special Designator	AWG Type (for Wire type only)	AWG Number (for Wire type only)	Wires length

Electrical Rating

P1
ENEC/CQC:
 0.1A 125/250VAC 48 VDC
 5E4 μ 25T120
UL/CUL:
 0.1A 125/250VAC 48VDC
 (Gold Plated Contact optional)

05
ENEC/CQC:
 6A 125/250VAC 1E4; μ
 3A 125/250VAC 30VDC 5E4
UL/CUL:
 5A 125/250VAC

Operating Force at pin Plunger Max

150
 150gf Max.
 (Only for G9P1)

200
 200gf Max.

300
 300gf Max.

Terminal Type

S Solder Terminals

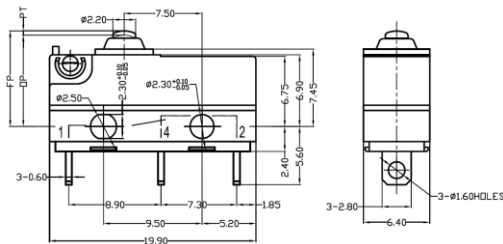

E Wires Leads to Bottom (500mm length)

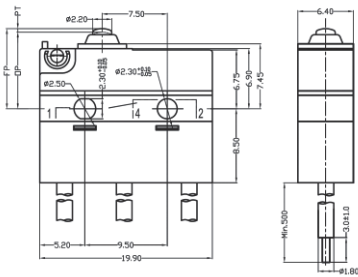

P Straight PCB Terminals

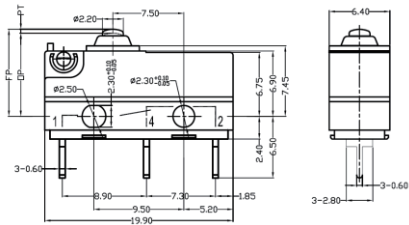

F Wires Leads to Side (Opposite to Pin plunger side) 500mm length

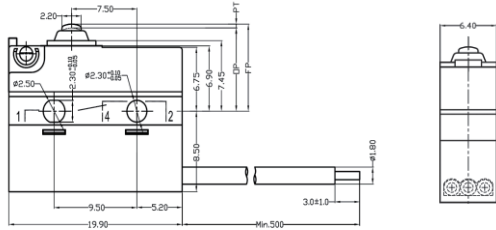

D 110# Quick Connect Terminals: 2.8x0.5mm

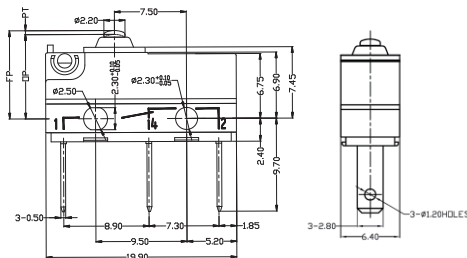

G Wires Leads to Side (Pin plunger side), length: 500mm

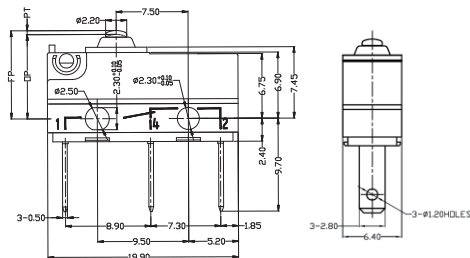

G9	05	200	S	00	D	1	A	XXX	XXX	XXX
Switch Type	Electrical Rating	Max Operating Force at pin Plunger	Terminal Style	Lever Type	Construction	Circuit Code	Special Designator	AWG Type (for Wire type only)	AWG Number (for Wire type only)	Wires length

Lever Type

00 Pin Plunger

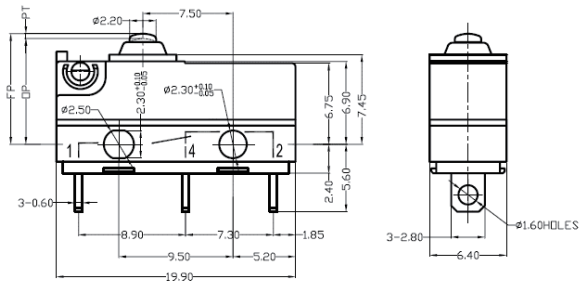

01 Short Straight Lever 17.7mm

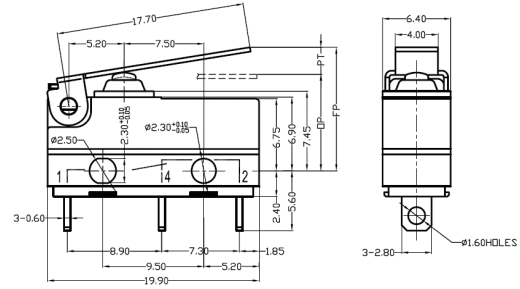

02 Standard Straight Lever 19.7mm

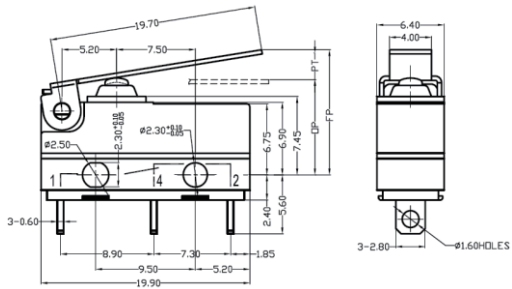

03 Long Straight Lever 25.8mm

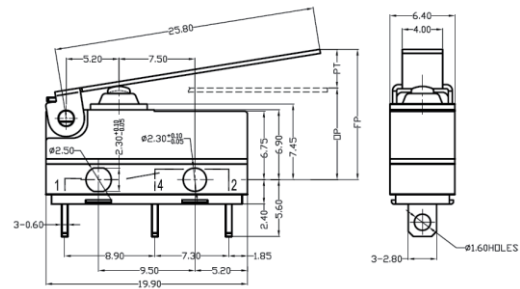

05 Simulated Roller Lever 18.9mm

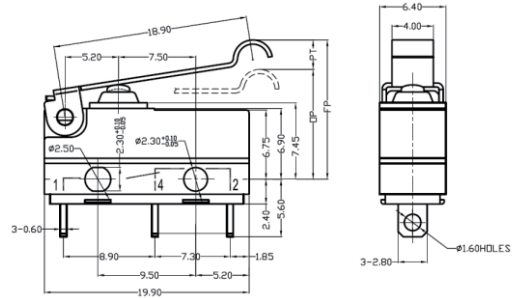

06 Roller Lever 15.7mm

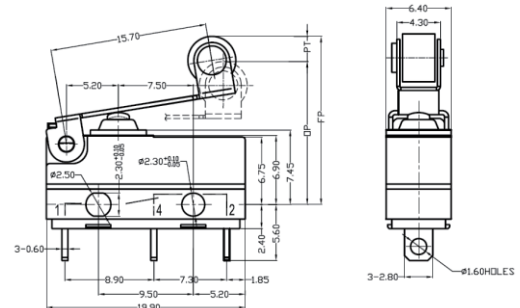

07 Small Simulated Roller Lever 19.0mm

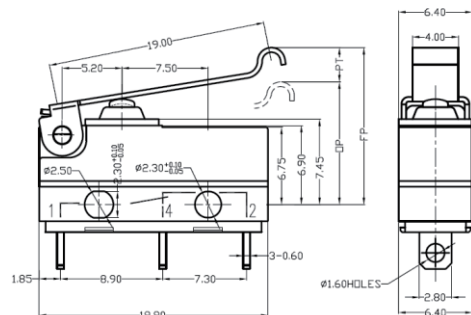

G9 □□-□□□ S02D1

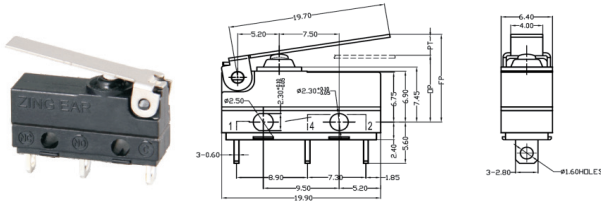

OF Max (gf)	RF Min (gf)	PT Max (mm)	OT Min (mm)	DT Max (mm)	FP Max (mm)	OP (mm)	
-150	50	6	4.8	0.7	0.8	12.5	8.8±1.3
-200	75	13	4.8	0.7	0.8	12.5	8.8±1.3

G9 □□-□□□ S03D1

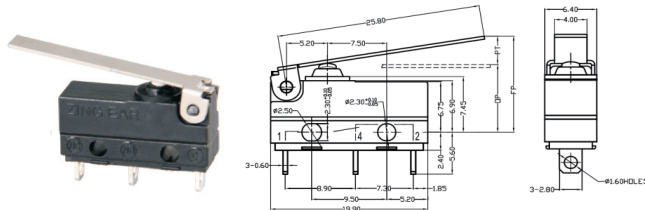

OF Max (gf)	RF Min (gf)	PT Max (mm)	OT Min (mm)	DT Max (mm)	FP Max (mm)	OP (mm)	
-150	40	5	6.3	1.0	1.0	13.5	8.8±1.8
-200	55	8	6.3	1.0	1.0	13.5	8.8±1.8

G9 □□-□□□ S05D1

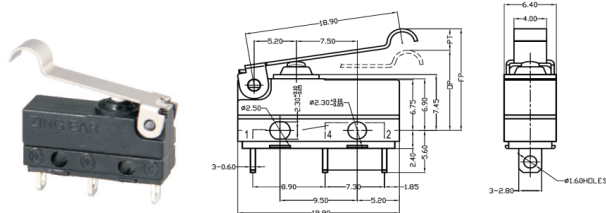

OF Max (gf)	RF Min (gf)	PT Max (mm)	OT Min (mm)	DT Max (mm)	FP Max (mm)	OP (mm)	
-150	50	6	4.6	0.7	0.8	15.5	11.8±1.5
-200	75	12	4.6	0.7	0.8	15.5	11.8±1.5

G9 □□-□□□ S06D1

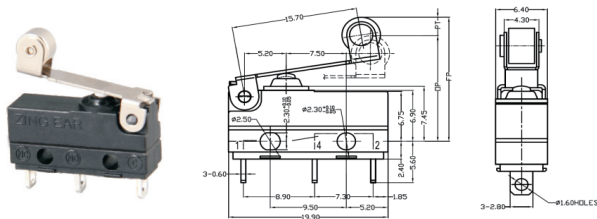

OF Max (gf)	RF Min (gf)	PT Max (mm)	OT Min (mm)	DT Max (mm)	FP Max (mm)	OP (mm)	
-150	65	10	4.3	0.6	0.7	17.5	14.5±1.1
-200	85	15	4.3	0.6	0.7	17.5	14.5±1.1

G9 □□-□□□ S07D1

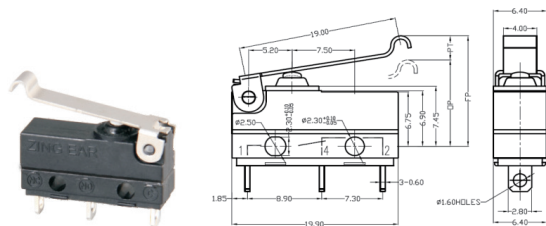

OF Max (gf)	RF Min (gf)	PT Max (mm)	OT Min (mm)	DT Max (mm)	FP Max (mm)	OP (mm)	
-150	50	9	4.6	0.7	0.8	14.0	10.7±1.5
-200	75	12	4.6	0.7	0.8	14.0	10.7±1.5

G9 □□-□□□ E00W1

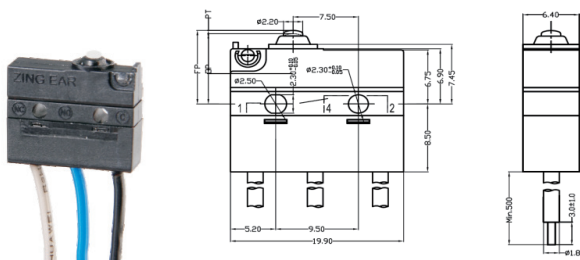

OF Max (gf)	RF Min (gf)	PT Max (mm)	OT Min (mm)	DT Max (mm)	FP Max (mm)	OP (mm)	
-150	150	30	1.2	0.6	0.2	9.4	8.4±0.3
-300	300	70	1.2	0.6	0.2	9.4	8.4±0.3

G9 □□-□□□ E01W1

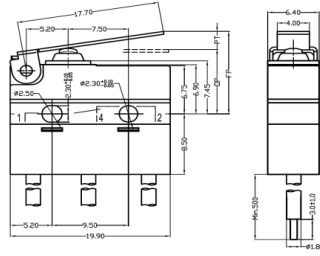

OF Max (gf)	RF Min (gf)	PT Max (mm)	OT Min (mm)	DT Max (mm)	FP Max (mm)	OP (mm)
-150	50	8	4.3	0.6	0.7	12.0
-300	105	20	4.3	0.6	0.7	12.0

G9 □□-□□□ E02W1

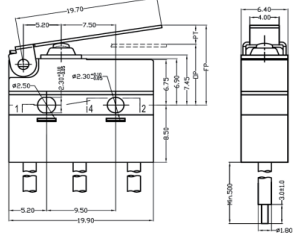

OF Max (gf)	RF Min (gf)	PT Max (mm)	OT Min (mm)	DT Max (mm)	FP Max (mm)	OP (mm)
-150	50	6	4.8	0.7	0.8	12.5
-300	95	18	4.8	0.7	0.8	12.5

G9 □□-□□□ E03W1

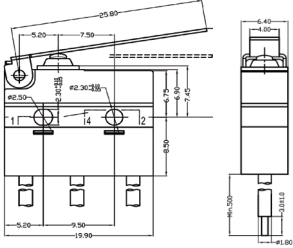

OF Max (gf)	RF Min (gf)	PT Max (mm)	OT Min (mm)	DT Max (mm)	FP Max (mm)	OP (mm)
-150	40	5	6.3	1.0	1.0	13.5
-300	75	13	6.3	1.0	1.0	13.5

G9 □□-□□□ E05W1

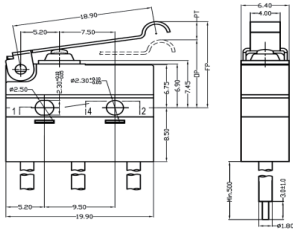

OF Max (gf)	RF Min (gf)	PT Max (mm)	OT Min (mm)	DT Max (mm)	FP Max (mm)	OP (mm)
-150	50	6	4.6	0.7	0.8	15.5
-300	95	18	4.6	0.7	0.8	15.5

G9 □□-□□□ E06W1

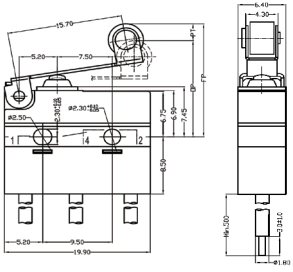

OF Max (gf)	RF Min (gf)	PT Max (mm)	OT Min (mm)	DT Max (mm)	FP Max (mm)	OP (mm)
-150	65	10	4.3	0.6	0.7	17.5
-300	110	25	4.3	0.6	0.7	17.5

G9 □□-□□□ E07W1

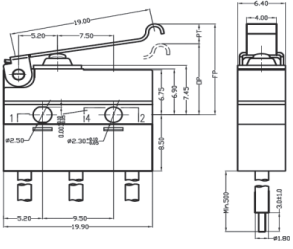

OF Max (gf)	RF Min (gf)	PT Max (mm)	OT Min (mm)	DT Max (mm)	FP Max (mm)	OP (mm)
-150	50	6	4.6	0.7	0.8	14.0
-300	95	18	4.6	0.7	0.8	14.0

G91 Series

Mini Micro Switch

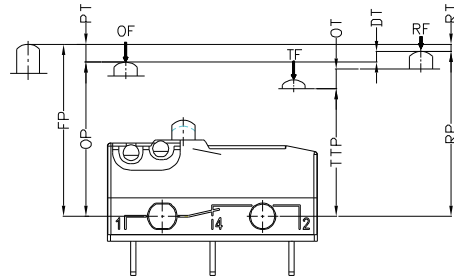

Features

- Small Compact Size
- Long Life, High Reliability
- Variety of Terminals and Levers
- Widely Used in Auto, Appliance and Other Industry Contract

Applications

- Car
- Phone
- Air-Conditioner
- Computer
- Alarm
- Timer
- Mixer & Meat Grinder
- Fax Machine
- Money Sorter
- Toy Car

Parameters

Rating	P1	ENEC/UL: 0.1A 125/250V 48VDC Gold Plated Contact Optional
	05	ENEC: 5A 125/250VAC; UL: 5A 1/8HP, 125/250VAC
	10	ENEC: 10(1.5)A 125/250VAC; UL: 10. 1A 1/4HP 125/250VAC
Operating Frequency	Electrical	10~30 cycles/minute
	Mechanical	120 cycles/minute
Contact Resistance (Initiative)		100mΩ Max
Insulation Resistance (at 500VDC)		100MΩ Min
Dielectric Strength		AC 1,000V RMS (50~60Hz)
Operating Temperature		-40°C ~ +125°C or -40°C ~ +85°C
Storage Humidity		85%RHMax
Service Life	Electrical	10,000 ~ 100,000 cycles (Depend on part No.)
	Mechanical	1,000,000 cycles

G91	05	150	S	00	D	1	
Switch Type	Electrical Rating	Max Operating Force at Pin Plunger	Terminal Type	Lever Type	Costruction	Circuit Code	Special Designator
G91 Series Micro Switch	P1 ENEC/CQC: 0.1A 125/250VAC 48VDC μ 25T125 5E4 UL/CUL 0.1A 125/250VAC 48VDC	100 100gf Max.	S Solder Terminals	00 No Lever Pin Plunger (Spherical surface)	D Mounting Hole 2.30mm	1 SPDT	General (Temperature grade 40T125)
	05 ENEC/CQC: 5A 125/250VAC 5E4 μ 40T125 UL/CUL 5A 125/250VAC	150 150gf Max.	P Straight PCB connect (0.6mm wide)	0A Cambered Surface	E Two sides posts Φ 1.8mmX2.8mm	2 SPST-NC	T Temperature grade 40T85
	10 ENEC/CQC: 10(1.5)A 125/250VAC μ 40T125 UL/CUL: 10.1A 1/4HP 125/250VAC	250 250gf Max.	D 0x11"x0.023" Quick connect 2.80x0.5mm	01 Short Straight Lever 17.7mm	F Right side posts Φ 1.8mmX2.8mm	3 SPST-NO	TXXX TXXX
			R Right side PCB connect	02 Std. Straight Lever 19.9mm	G Left side posts Φ 1.8mmX2.8mm		
			L Left side PCB connect	03 Long Straight Lever 25.8mm	... Other		
			K wide Straight PBC connect (0.6mm wide)	04 Long Straight Lever 55.30mm			
			... Other	05 Small Simulated Roller Lever 15.8mm			
				06 Roller Lever 15.8mm			
				07 Small Simulated Roller Lever 18.5mm			
				08 Small Simulated Roller Lever 19.00mm			

G91 series

Mounting Hole Dimensions

Mounting Post Type

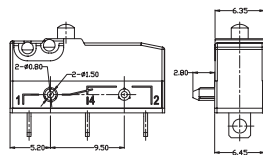

Mounting Hole Type

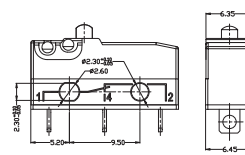

Terminal Dimensions

S Solder Terminals

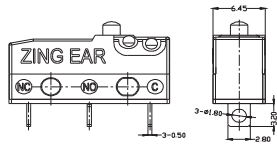

P Straight PCB Terminals (0.6mm wide)

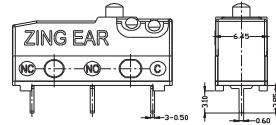

D 110# Quick Connect Terminals (2.8x0.5mm)

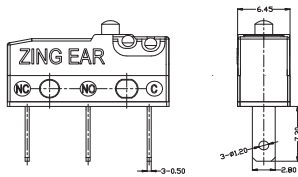

R Right Angled PCB Terminals

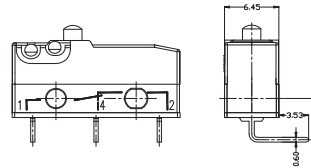

L Left Angled PCB Terminals

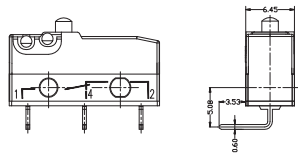

K Straight PCB Terminals (1.3mm wide)

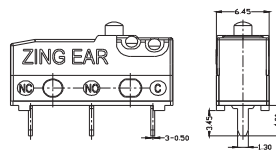

Dimensions and Operating Characteristics

Pin Plunger

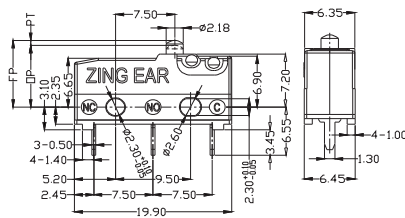

Part No.	Parameters							
	OF Max. (N)	RF Min. (gf)	PT Max. (mm)	OT Min. (mm)	MD Max. (mm)	OP (mm)		
G91□□-100□00D1	1.00	100	0.10	10	1.1	0.6	0.2	8.4±0.3
G91□□-150□00D1	1.50	150	0.35	35	1.1	0.6	0.2	8.4±0.3
G91□□-250□00D1	2.50	250	0.40	40	1.1	0.6	0.2	8.4±0.3
G91□□-300□00D1	3.00	300	0.60	60	1.1	0.6	0.2	8.4±0.3

Short Straight Lever

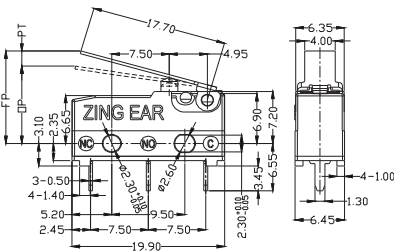

Part No.	Parameters							
	OF Max. (N)	RF Min. (gf)	PT Max. (mm)	OT Min. (mm)	MD Max. (mm)	OP (mm)		
G91□□-100□01D1	0.45	45	0.03	3	4.3	1.2	0.8	10.7±1.3
G91□□-150□01D1	0.60	50	0.08	8	4.3	1.2	0.8	10.7±1.3
G91□□-250□01D1	0.85	85	0.10	10	4.3	1.2	0.8	10.7±1.3
G91□□-300□01D1	1.20	120	0.15	15	4.3	1.2	0.8	10.7±1.3

Std. Straight Lever

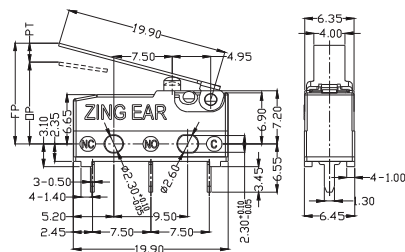

Part No.	Parameters							
	OF Max. (N)	RF Min. (gf)	PT Max. (mm)	OT Min. (mm)	MD Max. (mm)	OP (mm)		
G91□□-100□02D1	0.40	40	0.02	2	4.8	1.2	1.2	11.1±1.5
G91□□-150□02D1	0.50	50	0.06	6	4.8	1.2	1.2	11.1±1.5
G91□□-250□02D1	0.75	75	0.08	8	4.8	1.2	1.2	11.1±1.5
G91□□-300□02D1	1.10	110	0.12	12	4.8	1.2	1.2	11.1±1.5

Long Straight Lever

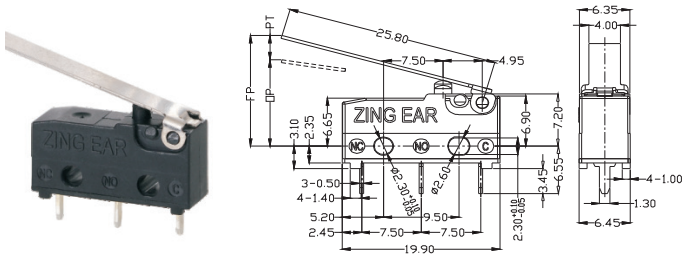

Part No.	Parameters							
	OF Max. (N)	OF Max. (gf)	RF Min. (N)	RF Min. (gf)	PT Max. (mm)	OT Min. (mm)	MD Max. (mm)	OP (mm)
G91□□-100□03D1	0.35	35	0.01	1	6.3	1.5	1.5	12.0±1.8
G91□□-150□03D1	0.40	40	0.04	4	6.3	1.5	1.5	12.0±1.8
G91□□-250□03D1	0.65	65	0.06	6	6.3	1.5	1.5	12.0±1.8
G91□□-300□03D1	0.90	90	0.10	10	6.3	1.5	1.5	12.0±1.8

Short Std. Simulated Roller Lever

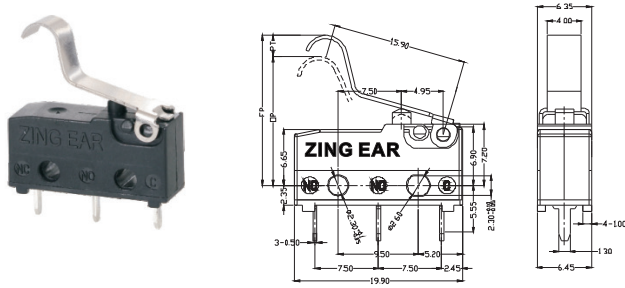

Part No.	Parameters							
	OF Max. (N)	OF Max. (gf)	RF Min. (N)	RF Min. (gf)	PT Max. (mm)	OT Min. (mm)	MD Max. (mm)	OP (mm)
G91□□-100□05D1	0.50	50	0.03	3	4.3	1.0	0.7	16.0±1.3
G91□□-150□05D1	0.65	65	0.08	8	4.3	1.0	0.7	16.0±1.3
G91□□-250□05D1	0.95	95	0.12	12	4.3	1.0	0.7	16.0±1.3
G91□□-300□05D1	1.30	130	0.16	16	4.3	1.0	0.7	16.0±1.3

Short Roller Lever

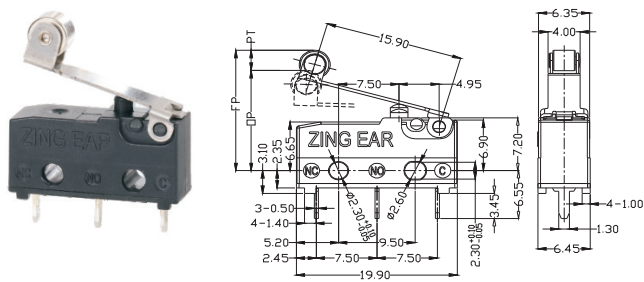

Part No.	Parameters							
	OF Max. (N)	OF Max. (gf)	RF Min. (N)	RF Min. (gf)	PT Max. (mm)	OT Min. (mm)	MD Max. (mm)	OP (mm)
G91□□-100□06D1	0.50	50	0.03	3	4.3	1.0	0.7	15.8±1.3
G91□□-150□06D1	0.65	65	0.08	8	4.3	1.0	0.7	15.8±1.3
G91□□-250□06D1	0.95	95	0.12	12	4.3	1.0	0.7	15.8±1.3
G91□□-300□06D1	1.30	130	0.16	16	4.3	1.0	0.7	15.8±1.3

Long Std. Simulated Roller Lever

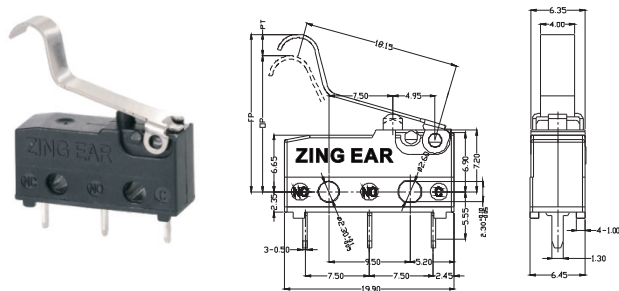

Part No.	Parameters							
	OF Max. (N)	OF Max. (gf)	RF Min. (N)	RF Min. (gf)	PT Max. (mm)	OT Min. (mm)	MD Max. (mm)	OP (mm)
G91□□-100□07D1	0.45	45	0.03	3	4.8	1.3	1.0	16.4±1.5
G91□□-150□07D1	0.60	60	0.08	8	4.8	1.3	1.0	16.4±1.5
G91□□-250□07D1	0.85	85	0.11	11	4.8	1.3	1.0	16.4±1.5
G91□□-300□07D1	1.20	120	0.15	15	4.8	1.3	1.0	16.4±1.5

G9A/G9B Series

3.5mm Travel Micro Switch



Features

- G9A Dust and Water Proof(IP67) / G9B Dust Proof(IP40)
- Small Compact Size Global Safety Approval
- Long Life and High Reliability, Variety of Terminals
- Variety of Levers Optional, Long Overtravel of 2.20mm Minimum
- Widely used in Auto Control, Appliance and Other industry Control

Applications

- Car
- Home Appliances
- Motor Control

Parameters

Rating	P1	0.1A 125/250VAC 30VDC
	05	5(2)A 125/250VAC 30VDC
Operating Frequency	Electrical	10~30 cycles/minute
	Mechanical	120 cycles/minute
Contact Resistance (Initiative)	100mΩ Max (It depends on the wire length for the type with wire)	
Insulation Resistance (at500VDC)	100MΩ Min	
Dielectric Strength	AC 1,000V RMS (50~60Hz)	
Storage Temperature	-40°C ~ +85°C	
Storage Humidity	85%RH Max	
Service Life	Electrical	50,000 cycles (Depend on part No.)
	Mechanical	250,000 cycles (IP67) 2,000,000 cycles (IP40)

G9A	05	200	S	01	A	300	T001
Switch Type	Electrical Rating	Max Operating Force at Pin Plunger	Terminal Type	Lever Type	Circuit Code	Wires lenght (AWG Number UL1007 AWG type 20#)	Custom Code
G9A IP67 G9B IP40 Series Micro Switch	P1 ENEC/CQC: 0.1A 125/250VAC 30VDC 40T85 μ 5E4	200 200gf Max.	S Solder Terminals	00 No Lever Pin Plunger	A SPDT	500mm length standard lead wires	T001
	05 ENEC/CQC: 5(2)A 125/250VAC 5A 30VDC 40T85 μ 5E4	300 300gf Max.	P Straight PCB terminal	01 01Plunger	B SPST-NC	300 300mm length	... Other
	... Other	... Other	E Molded lead wires downwards	... Other	C SPST-NO	...	
			F Molded lead wire to right side (Opposite to pin plunger side)				
			G Molded lead wire to left side (pin plunger side)				
			... Special terminals				

G9A/G9B series

Circuit Configuration

- A** SPDT
- B** SPST-NC
- C** SPST-NO

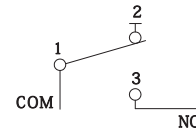
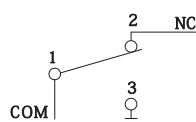
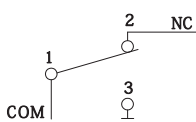

Mounting Hole Dimensions

Mounting Hole Dimension

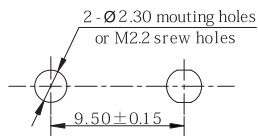

Mounting Hole Dimension of PCB Terminals

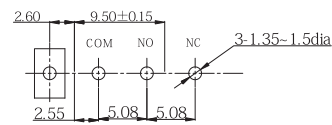

Terminal Dimensions

- S** Straight Solder Terminals
- E** Wires Leads to Bottom (500mm length)
- P** Straight PCB Terminals

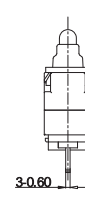
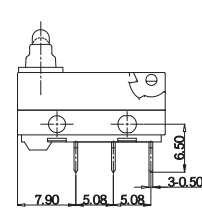
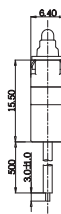
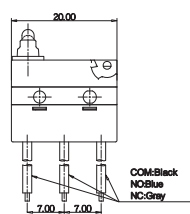
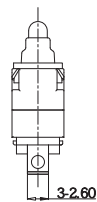
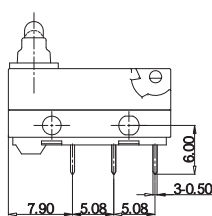

F Wires Leads to right Side (Opposite to Pin plunger side), 500mm length

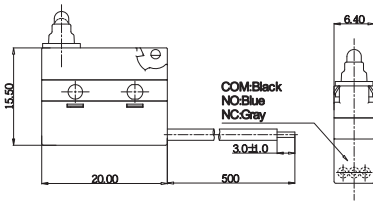

F Wires Leads to left Side (Opposite to Pin plunger side), 500mm length

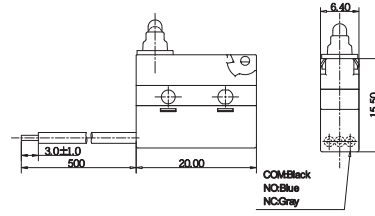

Lever Type

00 Pin Plunger

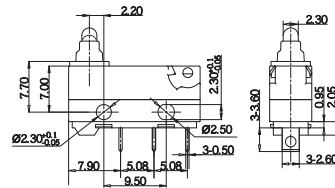

Dimensions and Operating Characteristics

G9A □□-□□ S00A

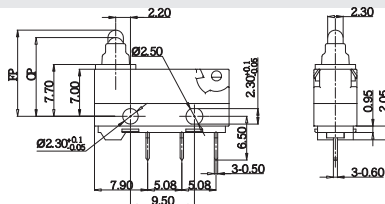

OF Max (gf)	RF Min (gf)	PT Max (mm)	OT Min (mm)	DT Max (mm)	FP Max (mm)	OP (mm)	
-150	150	30	1.2	0.6	0.2	9.4	8.4±0.3

G9A □□-□□ E00A-□□□

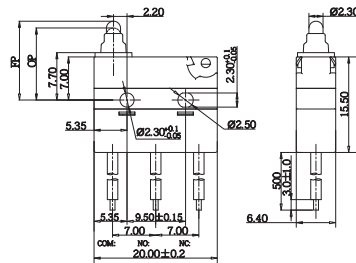

OF Max (gf)	RF Min (gf)	PT Max (mm)	OT Min (mm)	DT Max (mm)	FP Max (mm)	OP (mm)	
-150	50	8	4.3	0.6	0.7	12.0	8.8±1.2

G9B □□-□□ S00A

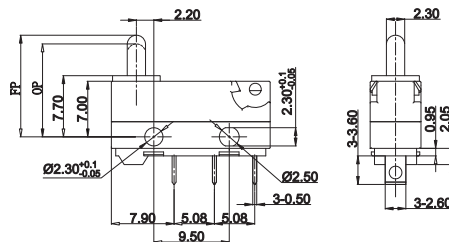

OF Max (gf)	RF Min (gf)	PT Max (mm)	OT Min (mm)	DT Max (mm)	FP Max (mm)	OP (mm)	
-150	50	6	4.8	0.7	0.8	12.5	8.8±1.3

G10 Series

Subminiature Micro Switch

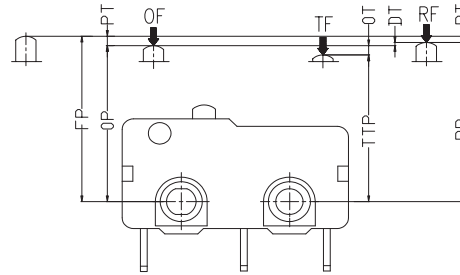

Features

- Small Compact Size
- Variety of Terminals
- Widely used in Appliance and Industry Control
- Long Life and High Reliability
- Variety of Levers Optional

Applications

- Walkie Talkie
- Telephone
- Battery Charger
- Mixer & Chopper
- Mouse
- Calculator
- Alarm
- Electric Knife
- Tester Machine
- Home Appliances
- Video Cassette Rewinder
- Electric Stapler
- Electric Pan
- Cordless Phone

Parameters

Rating	P1	0.1A 48VDC/125VAC (Gold plated Optional)
	03	1A/3A 125VAC
Operating Frequency	Electrical	10~30 cycles/minute
	Mechanical	120 cycles/minute
Contact Resistance (Initiative Value)		100mΩ Max (Depends on P/Ns)
Insulation Resistance (at500VDC)		at 500VDC, 100MΩ Min
Dielectric Strenght		AC 600V RMS (50~60Hz)
Storage Temperature		-40°C ~ +85°C
Storage Humidity		85%RHMax
Service Life	Electrical	6,000 ~ 100,000 cycles (Depend on P/Ns)
	Mechanical	1,000,000 cycles (5,000,000 cycles Optional)
Unit Net Weight		About 0.5g (Straight PCB type without lever)

G10	P1	150	S	00	A	XX	XX
Switch Type	Electrical Rating	Max Operating Force at Pin Plunger	Terminal Type	Lever Type	Circuit Code	Special Designator	Special Designator
G10 Series Micro Switch	P1 ENEC/CQC: 0.1A 125VAC 48VDC 40T85 μ 1E4 UL/CUL: 0.1A 125VAC 48VDC	90 90gf Max.	S Solder Terminals	00 No Lever Pin Plunger	A SPDT	General	Here means special designator letter, refer to product specification for details
	03 ENEC/CQC: 1A / 3A 125VAC 40T85 μ 1E4 UL/CUL: 0.1A 125VAC 48VDC	150 150gf Max.	P Straight PCB Terminals	01 10.0mm Short Straight Lever 0.39"		A Gold Plated	
			Q Snap in PBC Terminals	02 13.0mm Std. Straight Lever 0.52"		B Only for low current	
	... Other	... Other	M Short Solder Terminals	03 18.8mm Long Straight Lever 0.71"		12 Non-Halogen Material	
			R Right Angled PBC Terminals	05 11.8mm Simulated Roller Lever 0.46"			
			L Left Angled PBC Terminals	07 15.0mm Small Simulated Roller Lever 0.59"			
			K Long solder Terminals	09 30.0mm Long Straight Lever			
... Special Terminals			10 12.80mm Roller Lever				
			... Special Lever				

Mounting Hole Dimensions

Mounting Hole Dimension

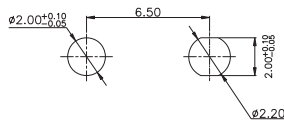

Mounting Hole Dimension of PCB Terminals

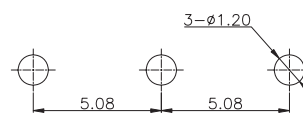

Mounting Hole Dimension of Right Angled PCB Terminals

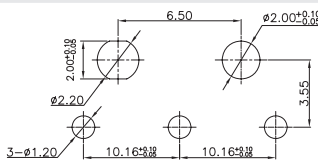

Mounting Hole Dimension of Left Angled PCB Terminals

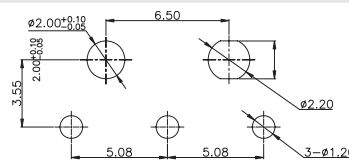

Terminal Dimensions

S Straight Solder Terminals

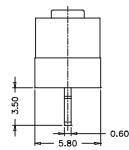
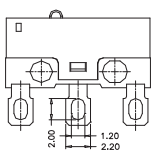

P Straight PCB Terminals

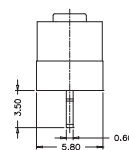
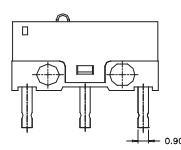

Q PCB snap-in(clip) Terminals

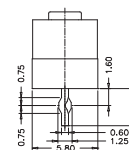
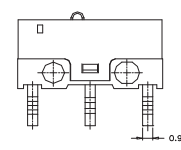

M Short Solder Terminals

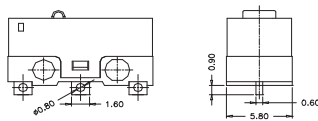

R Right Angled PCB Terminals

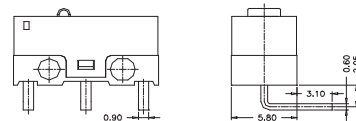

L Left Angled PCB Terminals

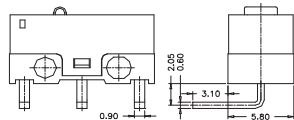

K Long Solder Terminals

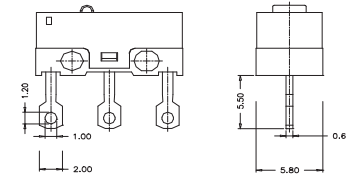

Circuit Configuration

SPDT

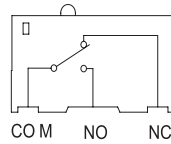

Dimensions and Operating Characteristics

G10 □□-□ P00A

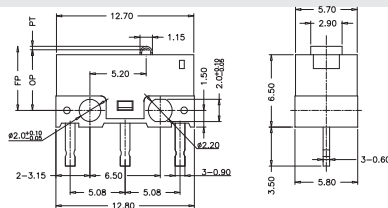

	OF Max (gf)	RF Min (gf)	PT Max (mm)	OT Min (mm)	DT Max (mm)	FP Max (mm)	OP (mm)
-090	90	15		0.2	0.2	6.0	5.5±0.3
-150	150	20	0.65				

G10 □□-□ P01A

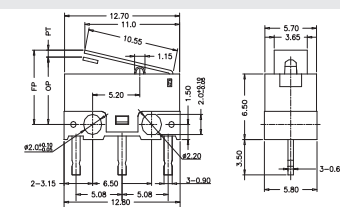

	OF Max (gf)	RF Min (gf)	PT Max (mm)	OT Min (mm)	DT Max (mm)	FP Max (mm)	OP (mm)
-090	40	6		0.3	0.6	0.8	6.25±0.8
-150	60	10	2.5				

G10 □□-□ P02A

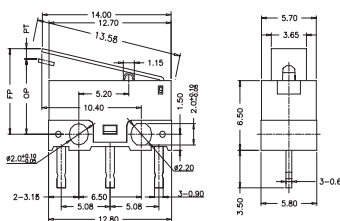

	OF Max (gf)	RF Min (gf)	PT Max (mm)	OT Min (mm)	DT Max (mm)	FP Max (mm)	OP (mm)
-090	30	4		0.3	0.8	8.8	6.35±0.9
-150	50	8	3.4				

G10 □□-□ P03A

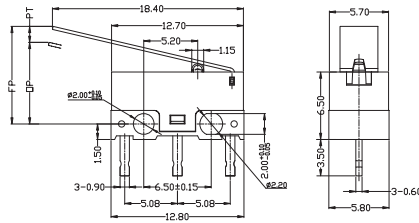
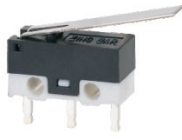

	OF Max (gf)	RF Min (gf)	PT Max (mm)	OT Min (mm)	DT Max (mm)	FP Max (mm)	OP (mm)
-090	40	3					
-150	50	5	4	0.05	1	10	7.5±1.5

G10 □□-□ P05A

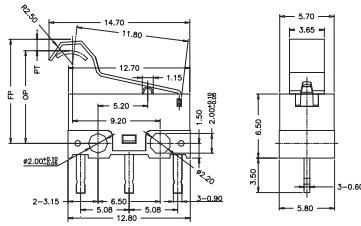

	OF Max (gf)	RF Min (gf)	PT Max (mm)	OT Min (mm)	DT Max (mm)	FP Max (mm)	OP (mm)
-090	40	5					
-150	50	8	3.0	0.3	0.7	12	9.5±0.8

G10 □□-□ P07A

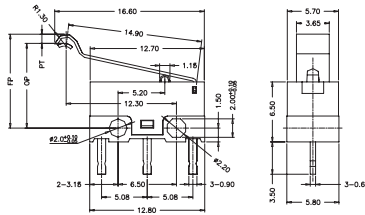

	OF Max (gf)	RF Min (gf)	PT Max (mm)	OT Min (mm)	DT Max (mm)	FP Max (mm)	OP (mm)
-090	30	5					
-150	50	8	3.5	0.3	1.1	11.5	8.2±1.0

G10 □□-□ P09A

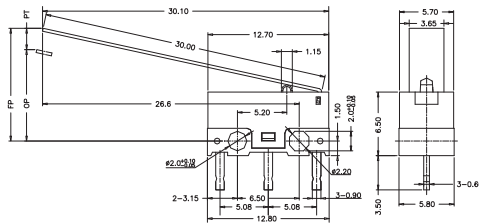

	OF Max (gf)	RF Min (gf)	PT Max (mm)	OT Min (mm)	DT Max (mm)	FP Max (mm)	OP (mm)
-090	15	2					
-150	23	3	6.9	0.4	2.5	14.0	8.2±2.1

G10 □□-□ P10A

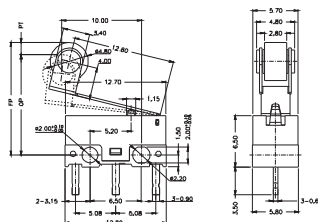

	OF Max (gf)	RF Min (gf)	PT Max (mm)	OT Min (mm)	DT Max (mm)	FP Max (mm)	OP (mm)
-090	35	3	5.5	0.3	0.8	16.5	13.0±1.3

G10A Series

Subminiature Micro Switch

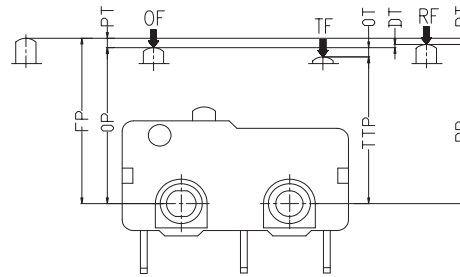

Features

- Small Compact Size
- Long Life and High Reliability
- Variety of Terminals
- Variety of Levers Optional
- Widely used in Appliance and Industry Contract

Applications

- Walkie Talkie
- Mouse
- Electric Knife
- Electric Stapler
- Telephone
- Calculator
- Mixer&Chopper
- Electric Pan
- Battery Charger
- Video Cassette Rewinder
- Cordless Phone
- Alarm
- Tester Machine
- Home Appliances

Parameters

Rating	P1	0.1A 125/250VAC 30VDC
	03	3A 125/250VAC 30VDC
Operating Frequency	Electrical	10~30 cycles/minute
	Mechanical	120 cycles/minute
Contact Resistance (Initiative)		100mΩ Max
Insulation Resistance (at500VDC)		at 500VDC, 100MΩ Min
Dielectric Strenght		AC 600V RMS (50~60Hz)
Storage Temperature		-40°C ~ +85°C
Storage Humidity		85%RHMax
Service Life	Electrical	10,000 cycles
	Mechanical	1,000,000 cycles

G10A	03	150	S	01	A	T001
Switch Type	Electrical Rating	Max Operating Force at Pin Plunger	Terminal Type	Lever Type	Circuit Code	Custom code
Switch Type	P1 ENEC/CQC 0.1A 125/250VAC 30VDC 40T85 μ 1E4 UL/CUL: 0.1A 125/250VAC 30VDC	150 150gf Max.	S Solder Terminals	00 No Lever Pin Plunger	A SPDT	General
	03 ENEC/CQC: 3A 125/250VAC 30VDC 40T85 μ 1E4 UL/CUL: 3A 125/250VAC 30VDC	... Other	P Straight PCB Terminals	01 01# Straight	B SPST-NC	T001
			Q Snap in PBC Terminals	... Other	C SPST-NO	... Other
			M Short Solder Terminals			
			R Right Angled PBC Terminals			
			L Left Angled PBC Terminals			
			K Long solder Terminals			
			... Special Terminals			

Mounting Hole Dimensions

Mounting Hole Dimension

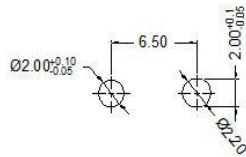

Mounting Hole Dimension of PCB Terminals

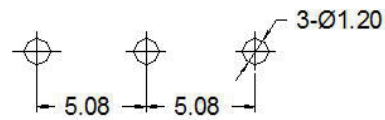

Mounting Hole Dimension of Right Angled PCB Terminals

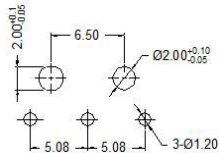

Mounting Hole Dimension of Left Angled PCB Terminals

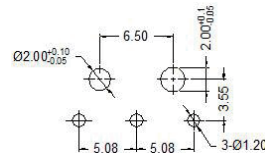

Terminal Dimensions

S Straight Solder Terminals

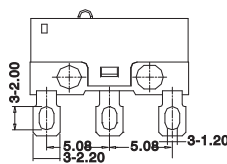

P Straight PCB Terminals

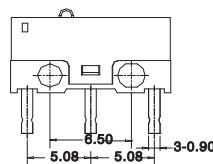

Q PCB snap-in(clip) Terminals

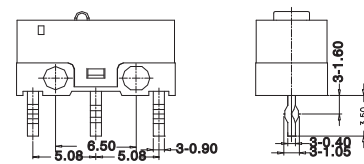

M Short Solder Terminals

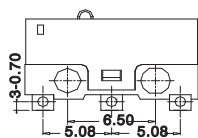

R Right Angled PCB Terminals

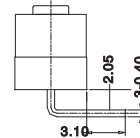
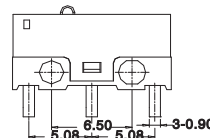
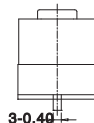

L Left Angled PCB Terminals

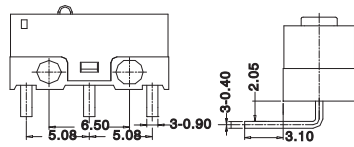

K Long Solder Terminals

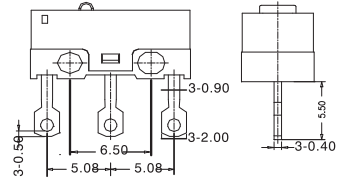

Circuit Configuration

SDST

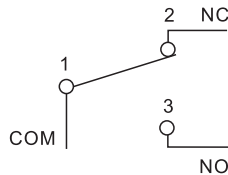

Dimensions and Operating Characteristics

G10A □□-□ P00A

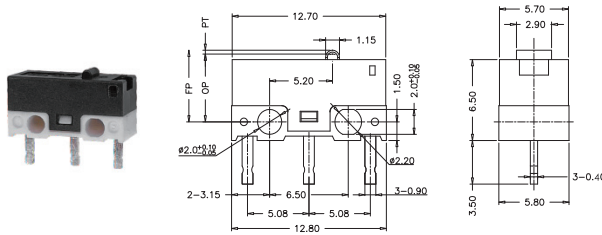

OF Max (gf)	RF Min (gf)	PT Max (mm)	OT Min (mm)	DT Max (mm)	FP Max (mm)	OP (mm)	
-150	150	20	0.65	0.3	0.6	9	6.65±0.9

G10A □□-□ P01A

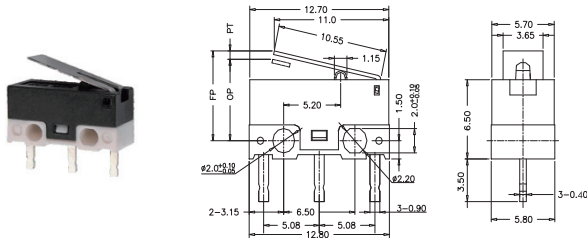

OF Max (gf)	RF Min (gf)	PT Max (mm)	OT Min (mm)	DT Max (mm)	FP Max (mm)	OP (mm)
-150	60	10	0.3	0.6	9	6.65±0.9

G10A □□-□ P02A

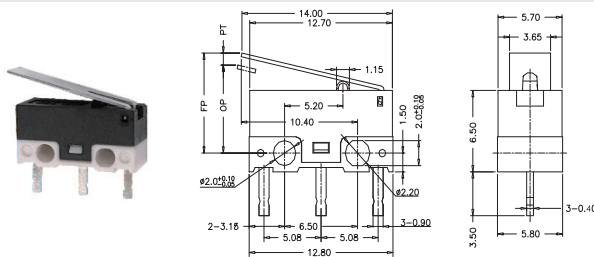

OF Max (gf)	RF Min (gf)	PT Max (mm)	OT Min (mm)	DT Max (mm)	FP Max (mm)	OP (mm)
-150	50	8	0.3	0.8	9.5	7.0±1.2

G10A □□-□ P03A

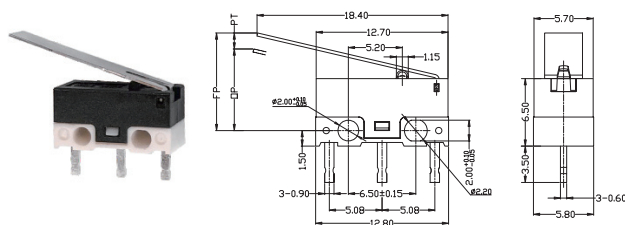

OF Max (gf)	RF Min (gf)	PT Max (mm)	OT Min (mm)	DT Max (mm)	FP Max (mm)	OP (mm)
-150	50	5	0.5	1	10	7.5±1.5

G10B Series

Subminiature Sealed Micro Switch

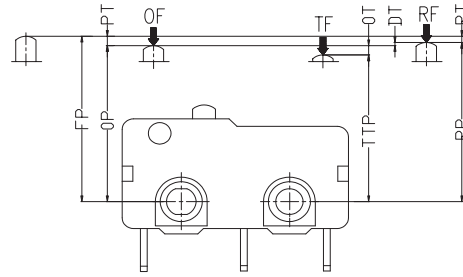

Features

- Designed For Water and Dust Tight (IP67)
- Small Compact Size
- Long Life and High Reliability
- Variety of Levers Optional
- Widely used in Automotive Electronics, Appliance and Industrial Control etc.

Applications

- Car
- Air- conditioner
- Communication
- HomeAppliance

Parameters

Rating	P1	0.1A 125/250VAC 30VDC
	03	3A 125/250VAC 30VDC
Operating Frequency	Electrical	10~30 cycles/minute
	Mechanical	120 cycles/minute
Contact Resistance (Initiative)		100mΩ Max
Insulation Resistance (at500VDC)		at 500VDC, 100MΩ Min
Dielectric Strenght		AC 600V RMS (50~60Hz)
Storage Temperature		-40°C ~ +85°C
Storage Humidity		85%RHMax
Service Life	Electrical	10,000 cycles
	Mechanical	300,000 cycles

G10B	03	150	S	01	A	300	T001
Switch Type	Electrical Rating	Max Operating Force at Pin Plunger	Terminal Type	Lever Type	Circuit Code	Wires lenght (AWG Number UL1007 AWG type 20#)	Custom Code
Switch Type	P1 ENEC/CQC: 0.1A 125/250VAC 30VDC 40T85 μ 1E4 UL/CUL 0.1A 125/250VAC 30VDC	150 150gf Max.	E Molded lead wires downwards	00 No Lever Pin Plunger	A SPDT	300 300mm lenght standard lead wires	General
	03 ENEC/CQC: 3A 125/250VAC 30VDC 40T85 μ 1E4 UL/CUL 3A 125/250VAC 30VDC	... Other	G Molded lead Wires Leads to left Side (Pin plugger side)	02 02# Straight	B SPST-NC	100 100mm length	T001
			F Molded lead Wires Leads to right Side (Opposite pin plugger side)	03 03# Straight	C SPST-NO	... Other	... Other
			S Solder Terminals	... Other			
			P Straight PBC Terminals				
			Q Snap in PBC Terminals				
		... Special terminals					

Mounting Hole Dimensions

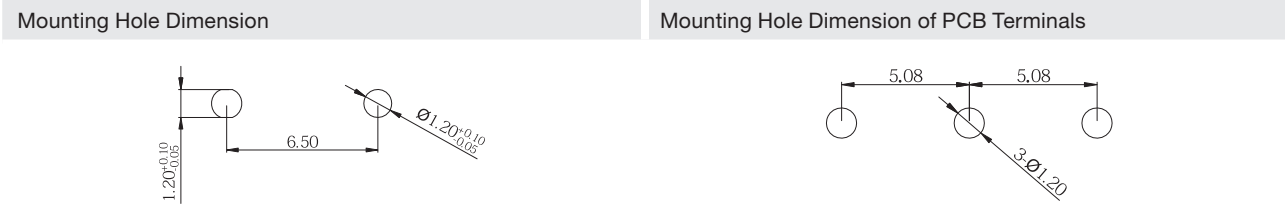

Terminal Dimensions Terminal thickness: 0.4mm

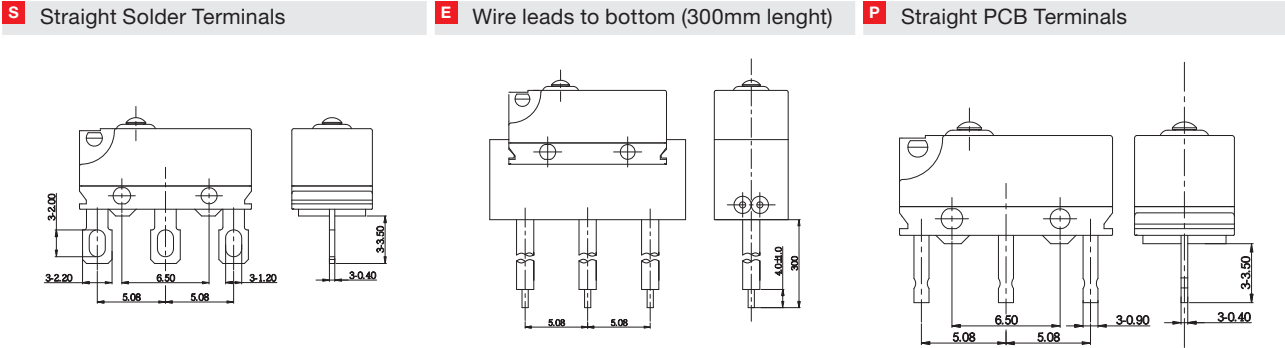

F Wire leads to right side (Opposite to pin plunger side) 300mm length

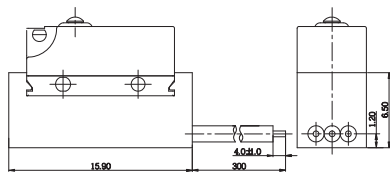

Q PCB SNAP-IN (Clip) Terminals

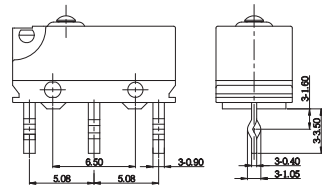

G Wire leads to left side (pin plunger side) 300mm length

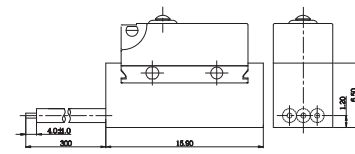

Lever Type

00 Pin Plunger

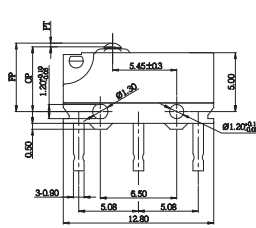

02 02# Lever

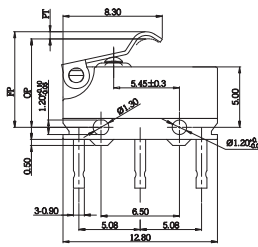

03 03# Lever

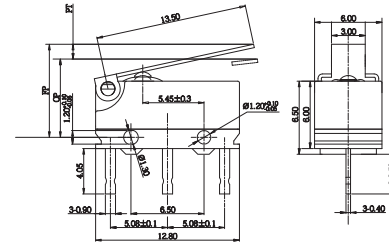

Dimensions and Operating Characteristics

G10B □□-□ P00A

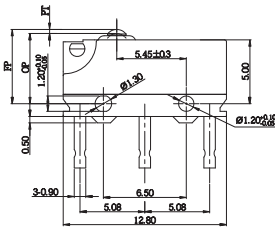

OF Max (gf)	RF Min (gf)	PT Max (mm)	OT Min (mm)	DT Max (mm)	FP Max (mm)	OP (mm)
-150	150	20	0.65	0.2	0.2	6.1
						5.5±0.3

G10B □□-□ P02A

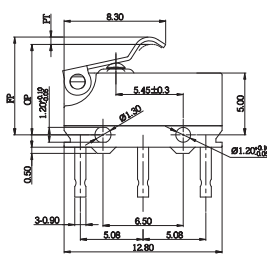
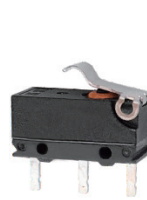

OF Max (gf)	RF Min (gf)	PT Max (mm)	OT Min (mm)	DT Max (mm)	FP Max (mm)	OP (mm)
-150	90	15	1.5	0.3	0.7	8.7
						7.5±0.6

G10B □□-□ P03A

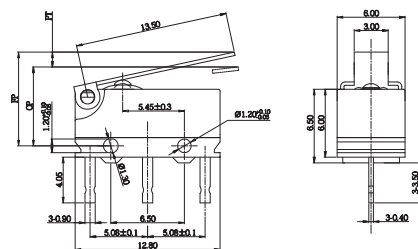

OF Max (gf)	RF Min (gf)	PT Max (mm)	OT Min (mm)	DT Max (mm)	FP Max (mm)	OP (mm)
-150	50	8	3.4	0.3	0.8	8.8
						6.7±1.0

Note:

All products information in this catalogue is for reference only, we may change the specification in the catalogue before any notification in advance. Please contact with sales representative to get the newly individual product specification before you purchase it.



Everel Group S.P.A.
[Headquarter]
Via Cavour, 9
37067 Valeggio sul Mincio (VR) - Italy
tel. +39 045 6313711
fax +39 045 6313730

www.everelgroup.com

